



TEST REPORT

Maintenance testing of generic cabling products: Unscreened channel, Class E, 6 connector model

Performed for Excel

Report no.: 12225672-01

DANAK-19/22846

Page 1 of 56

1 appendix



GTS

ADVANCED
TECHNOLOGY GROUP

FORCE Technology
Venlighedsvej 4
2970 Hørsholm
Tel. +45 43 25 14 00

FORCE Technology Norway AS
Nye Vakås vei 32
1395 Hvalstad, Norway
+47 64 00 35 00
+47 64 00 35 01
info@forcetechnology.no

FORCE Technology Sweden AB
Tallmätargatan 7
72134 Västerås, Sweden
+46 (0)21-490 3000
+46 (0)21-490 3001
info@forcetechnology.se

FORCE Technology
Park Allé 345
2605 Brøndby, Denmark
+45 43 25 00 00
+45 43 25 00 10
info@forcetechnology.dk
www.forcetechnology.com



OVERVIEW

Title	Maintenance testing of generic cabling products
Product description	Unscreened channel, Class E, 6 connector model
Product identification	See clause 2
EC Cabling product ID	5141
Compliance statement	2022-492
Accreditation no.	DANAK-19/22846
Project no.	12225672-01
Original accreditation no.	DANAK-19J2065
Original project no.	N312586-01
Test object received	3 August 2022
Test period	August 2022
Client	Excel Excel House Junction Six Industrial Park Electric Avenue Birmingham, B6 7JJ United Kingdom
Contact	Neil Payne
Specification	ISO/IEC 11801-1
Results	Compliance with specifications is verified
Prepared by	Lars Bjerring
Reviewed by	Nis Jepsen
Date	9 August 2022
Responsible	

Lars Lindskov Pedersen, Test Manager
FORCE LAN Components and Systems Testing



Disclaimer

This report is issued under the rules of DANAK (Danish Accreditation) and ILAC (International Laboratory Accreditation Cooperation) including its MRA (Mutual Recognition Arrangement). Further information can be found at www.danak.dk and www.ilac.org.

The report must not be reproduced, except in full, without the written approval of FORCE Technology.

The test results only relate to the items tested.

The original version of the report is archived in FORCE Technology's database and is sent in electronic duplicate to the customer. The stored version of the report at FORCE Technology prevails as documentation for its contents and validity.

TABLE OF CONTENTS

1	Summary	5
2	Channel components.....	6
3	Conclusion	8
4	Test results	9
4.1	Cabling under test.....	9
4.2	Cable marking	9
4.3	High frequency transmission test results. Channel #1 (85 m horizontal cable)	10
4.4	High frequency transmission test results. channel #2 (15 m horizontal cable).....	28
4.5	Resistance properties	46
5	Reference to applicable standards and documents	47
5.1	Generic cabling standards	47
5.2	Special requirements for EC VERIFIED	47
6	Test procedures.....	48
6.1	Electrical test.....	48
6.1.1	Attenuation (Att).....	49
6.1.2	Return loss (RL).....	50
6.1.3	Near end crosstalk (NEXT).....	51
6.1.4	Powersum near end crosstalk (PSNEXT).....	51
6.1.5	Attenuation to crosstalk loss ratio (ACR-N)	52
6.1.6	Power sum ACR (PSACR-N).....	52
6.1.7	Attenuation to crosstalk ratio-far end (ACR-F).....	52
6.1.8	Power sum attenuation to crosstalk ratio far end (PSACR-F)	52
6.1.9	Unbalance attenuation, near end (Transverse conversion loss, TCL)	53
6.1.10	DC loop resistance	54
6.1.11	Propagation delay	54
6.1.12	Delay skew.....	54
	Appendix 1 Test software	56



1 Summary

A communication channel has been tested for compliance with generic cabling standards.

The purpose of the testing was to maintain certification of the channel according to the EC VERIFIED programme.

The channel for this electrical performance test was assembled and delivered to FORCE by the client.

The channel testing has been performed under laboratory conditions at the EC Cabling Group of FORCE.

This report firstly gives a detailed description of the channels under test. Then the conclusion is given followed by the test results. At last, an overview of the test procedures and applied standards are given.

2 Channel components

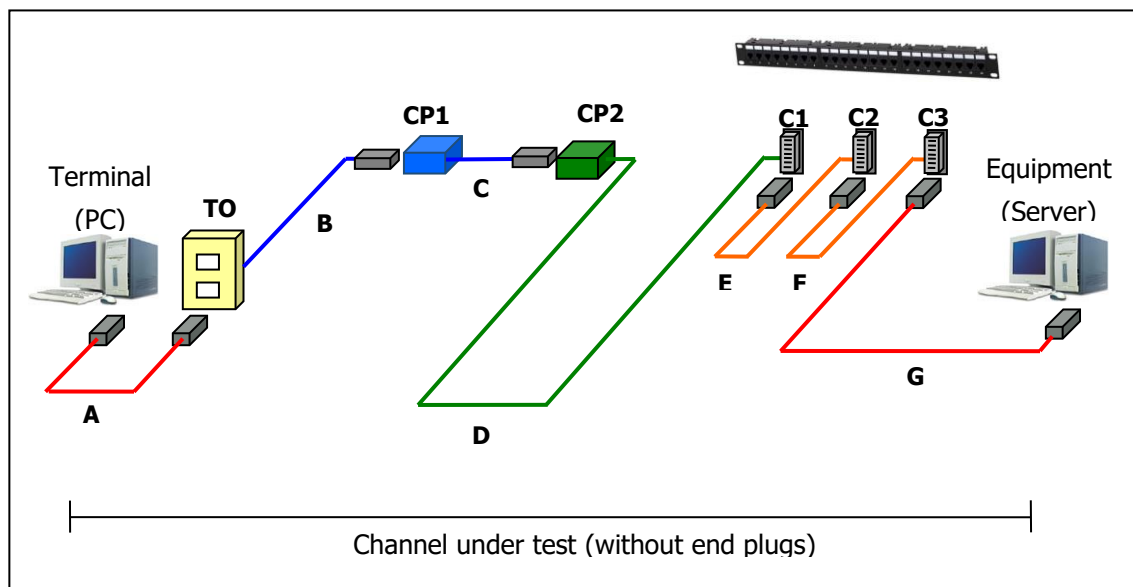

Figure 1. Channel definition (4 connector model).

The channel consists of the following components:

Item	Name	Cable type	Length	Connecting hardware
A	Terminal cord	Flexible cable	4 m	1 plug
B, C	Consolidation point cable	Flexible cable	3 m 1 m	1 socket, 1 plug 1 socket, 1 plug
D	Horizontal cable	Horizontal cable	85 m (CH #1) 15 m (CH #2)	2 sockets
E, F	Patch cord	Flexible cable	1 m 1 m	1 socket, 1 plug 1 socket, 1 plug
G	Equipment cord	Flexible cable	3 m	1 plug
TO	Telecommunications Outlet / Wall Outlet			
CP1, CP2	Consolidation Point connector (Sockets)			
C1, C2, C3	Horizontal cross-connector / Floor Distributor / Patch panel			



Test samples and qualification status

Horizontal cable:

100-071 Excel Category 6 unshielded (U/UTP) cable LS0H (EC VERIFIED)

RJ45 connector for telecommunications outlet, consolidation point, and patch panel:

100-215 Excel Category 6 unshielded U/UTP Low Profile Toolless Keystone Jack, Butterfly Style (EC VERIFIED)

Terminal cord:

100-357 Excel Category 6 unshielded UTP patch lead LS0H, booted (4 m) (EC VERIFIED)

Patch cord:

100-310 Excel Category 6 unshielded UTP patch lead LS0H, booted (1 m), terminated with jack 100-215

Consolidation point cord:

100-310 Excel Category 6 unshielded UTP patch lead LS0H, booted (1 m), terminated with jack 100-215

100-312 Excel Category 6 unshielded UTP patch lead LS0H, booted (3 m), terminated with jack 100-215

Equipment cord:

100-312 Excel Category 6 unshielded UTP patch lead LS0H, booted (3 m) (EC VERIFIED)



3 Conclusion

The tested sample complies with the applied requirements.

The test results are only applicable for the tested sample.

4 Test results

4.1 Cabling under test



Figure 2. Photo of product under test

4.2 Cable marking

Table 1. Cable marking, horizontal cable

Characteristic	Result
Type of printing	Jet ink
Colour of text	Black text on a purple jacket
Text	231 M EXCEL 100-071 4PR 23AWG UTP LSOH --- LAN CABLE CAT6 BATCH NO 20211001003 EN50575 Class Dca WWW.EXCEL-NETWORKING.COM

Table 2. Cable marking, cord

Characteristic	Result
Type of printing	Jet ink
Colour of text	White text on a grey jacket
Text	excel CAT.6 UTP PATCH CABLE ETL VERIFIED TO TIA/EIA-568-B.2-1 CAT.6 LSZH 20220108

4.3 High frequency transmission test results. Channel #1 (85 m horizontal cable)

NEAR END CROSSTALK (NEXT). From terminal end

Channel #1. Worst case margin: 8.8 dB at 215.1 MHz for Blue /Orange pair.

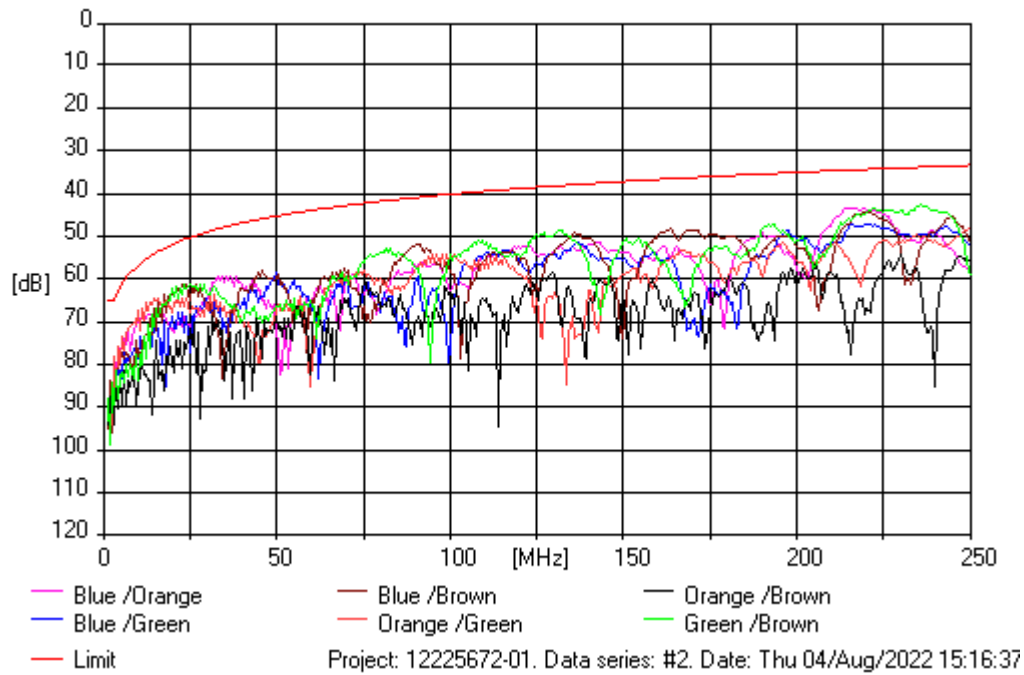

Table 3. Worst case margins at selected nominal frequencies.

Nominal Freq. [MHz]	Meas. Freq. [MHz]	Meas. value [dB]	Limit value [dB]	Calc. margin [dB]
1	1.0	87.7	65.0	22.7
4	4.1	75.7	62.8	12.8
16	15.9	64.5	53.3	11.2
100	100.0	54.0	39.9	14.0
250	250.0	48.1	33.1	15.0

PS NEAR END CROSSTALK(PSNEXT). From terminal end

Channel #1. Worst case margin: 8.6 dB at 219.5 MHz for Blue pair.

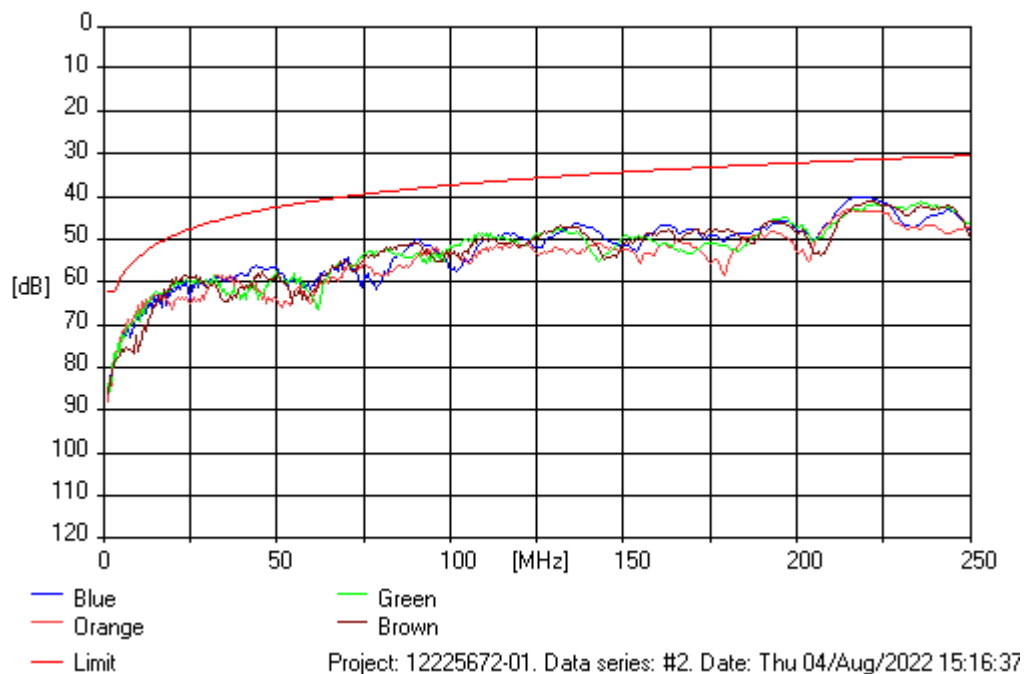

Table 4. Worst case margins at selected nominal frequencies.

Nominal Freq. [MHz]	Meas. Freq. [MHz]	Meas. value [dB]	Limit value [dB]	Calc. margin [dB]
1	1.0	83.9	62.0	21.9
4	4.1	74.2	60.3	13.8
16	15.9	62.5	50.6	11.9
100	100.0	51.1	37.1	14.0
250	250.0	46.5	30.2	16.3

RETURN LOSS. From terminal end

Channel #1. Worst case margin: 5.3 dB at 1.6 MHz for Orange pair.

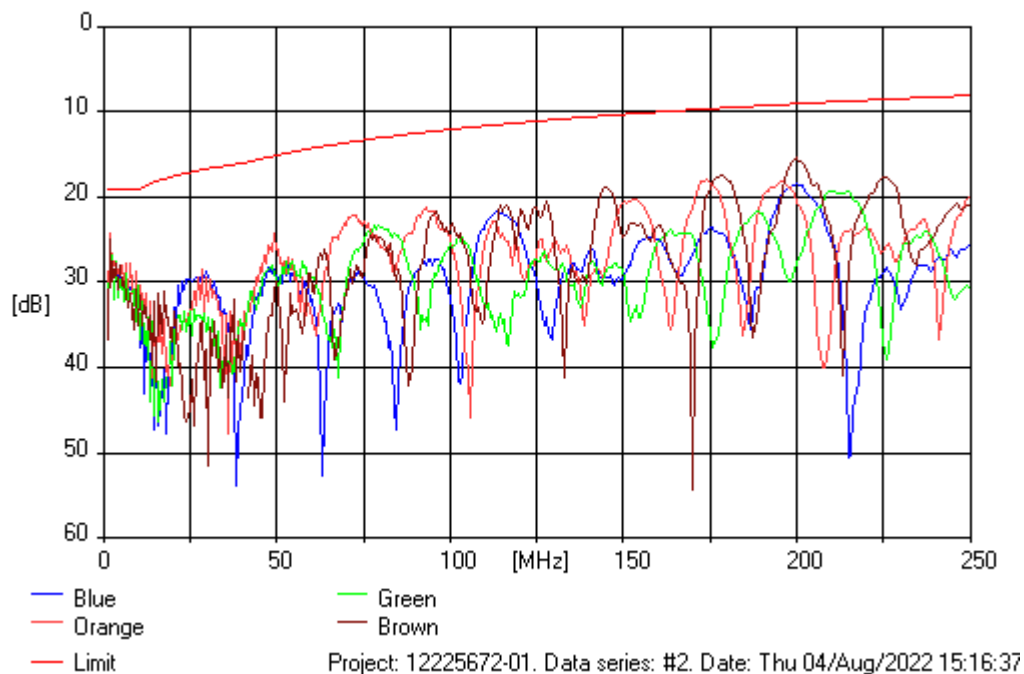

Table 5. Worst case margins at selected nominal frequencies.

Nominal Freq. [MHz]	Meas. Freq. [MHz]	Meas. value [dB]	Limit value [dB]	Calc. margin [dB]
1	1.0	33.2	19.0	14.2
4	4.1	28.8	19.0	9.8
16	15.9	31.2	18.0	13.2
100	100.0	23.6	12.0	11.5
250	250.0	19.9	8.0	11.9

ATTENUATION TO CROSSTALK RATIO, NEAR END (ACR-N). From terminal end
 Channel #1.. Worst case margin: 11.2 dB at 20.9 MHz for Green/Brown-Green pair.

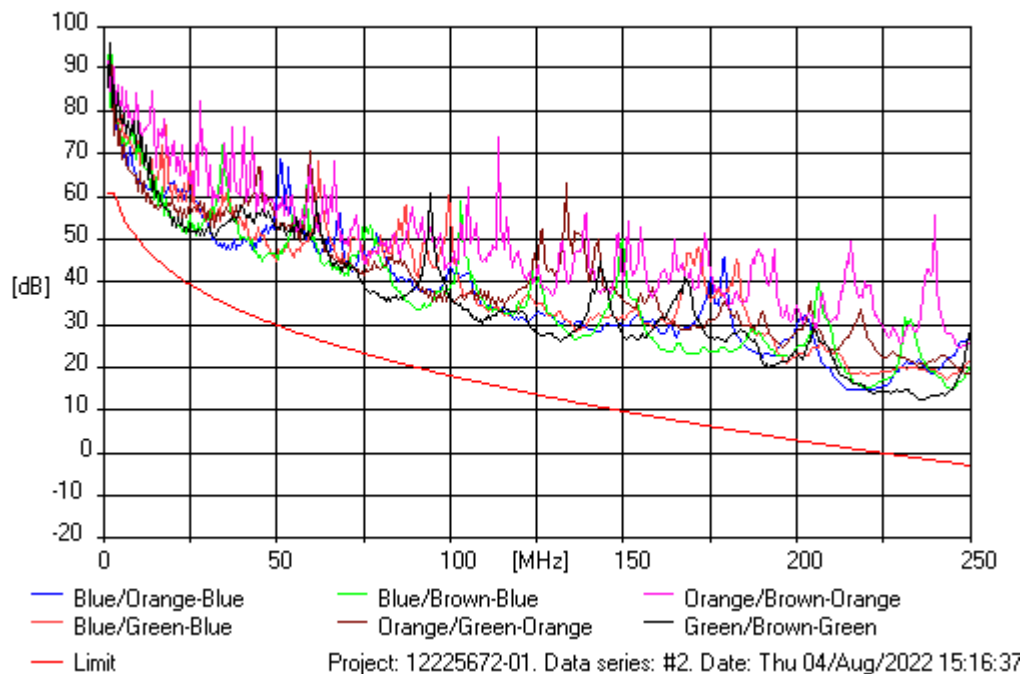

Table 6. Worst case margins at selected nominal frequencies.

Nominal Freq. [MHz]	Meas. Freq. [MHz]	Meas. value [dB]	Limit value [dB]	Calc. margin [dB]
1	1.0	85.8	61.0	24.8
4	4.1	72.1	58.6	13.5
16	15.9	57.4	45.0	12.5
100	100.0	35.2	18.2	17.0
250	250.0	18.3	-2.8	21.1

PS ATT TO CROSSTALK RATIO, NEAR END (PSACR-N). From terminal end
 Channel #1. Worst case margin: 11.3 dB at 20.9 MHz for Brown pair.

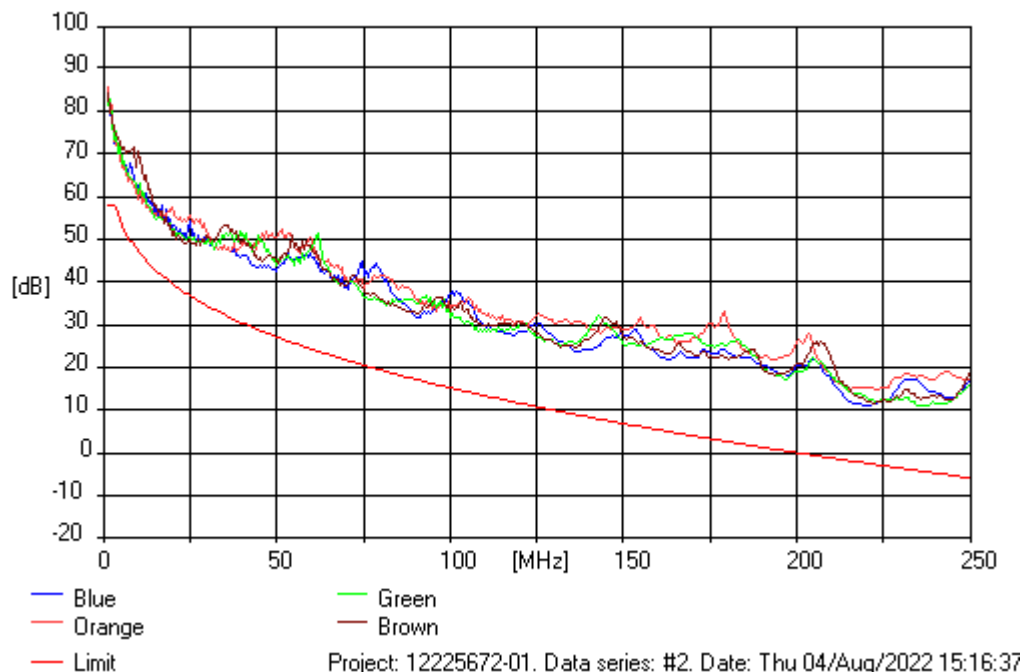

Table 7. Worst case margins at selected nominal frequencies.

Nominal Freq. [MHz]	Meas. Freq. [MHz]	Meas. value [dB]	Limit value [dB]	Calc. margin [dB]
1	1.0	81.9	58.0	23.9
4	4.1	70.6	56.1	14.5
16	15.9	55.3	42.3	13.0
100	100.0	32.1	15.4	16.7
250	250.0	16.0	-5.8	21.8

TRANSVERSE CONVERSION LOSS (TCL). From terminal end

Channel #1. Worst case margin: 17.4 dB at 208.9 MHz for Orange pair.

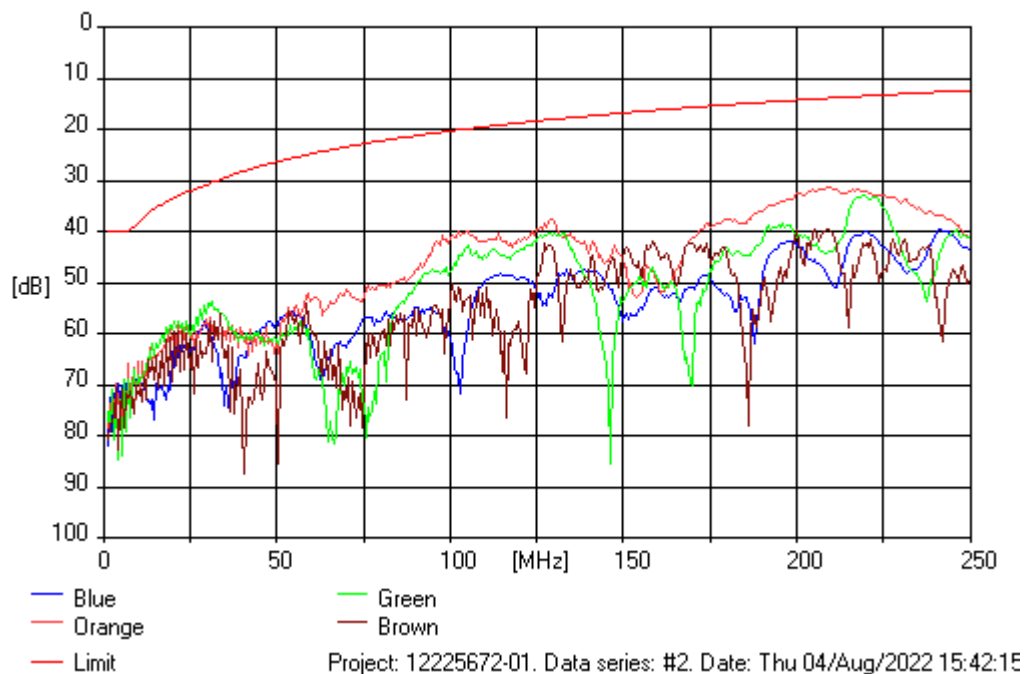

Table 8. Worst case margins at selected nominal frequencies.

Nominal Freq. [MHz]	Meas. Freq. [MHz]	Meas. value [dB]	Limit value [dB]	Calc. margin [dB]
1	1.0	75.3	40.0	35.3
4	4.1	69.7	40.0	29.7
16	15.9	62.7	35.0	27.8
100	100.0	41.3	20.3	21.0
250	250.0	41.3	12.3	29.0

NEAR END CROSSTALK (NEXT). From equipment end

Channel #1. Worst case margin: 2.8 dB at 215.1 MHz for Green /Brown pair.

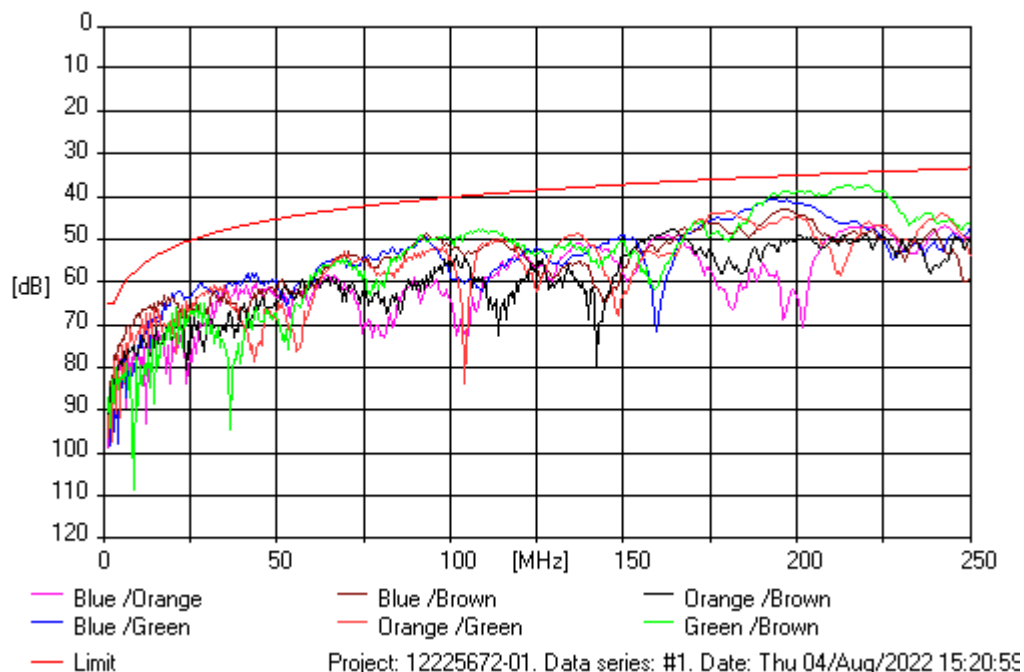

Table 9. Worst case margins at selected nominal frequencies.

Nominal Freq. [MHz]	Meas. Freq. [MHz]	Meas. value [dB]	Limit value [dB]	Calc. margin [dB]
1	1.0	87.1	65.0	22.1
4	4.1	74.5	62.8	11.7
16	15.9	64.3	53.3	11.0
100	100.0	49.8	39.9	9.9
250	250.0	46.0	33.1	12.9

PS NEAR END CROSSTALK(PSNEXT). From equipment end

Channel #1. Worst case margin: 3.8 dB at 196.5 MHz for Green pair.

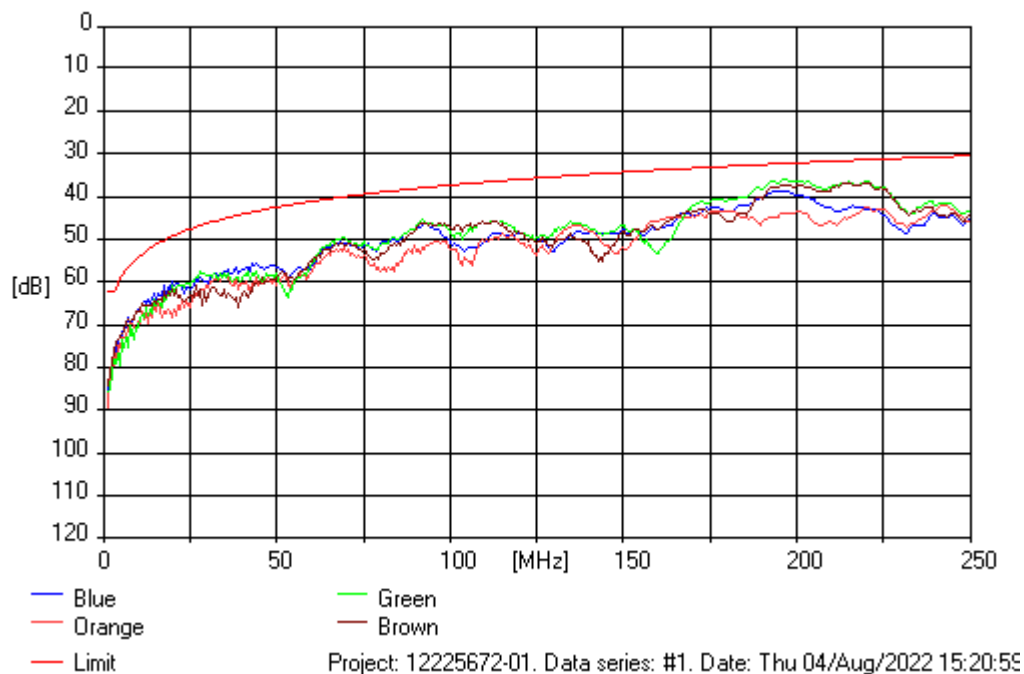

Table 10. Worst case margins at selected nominal frequencies.

Nominal Freq. [MHz]	Meas. Freq. [MHz]	Meas. value [dB]	Limit value [dB]	Calc. margin [dB]
1	1.0	84.3	62.0	22.3
4	4.1	73.2	60.3	12.9
16	15.9	62.4	50.6	11.8
100	100.0	47.1	37.1	10.0
250	250.0	43.1	30.2	12.9

RETURN LOSS. From equipment end

Channel #1. Worst case margin: 5.2 dB at 1.6 MHz for Orange pair.

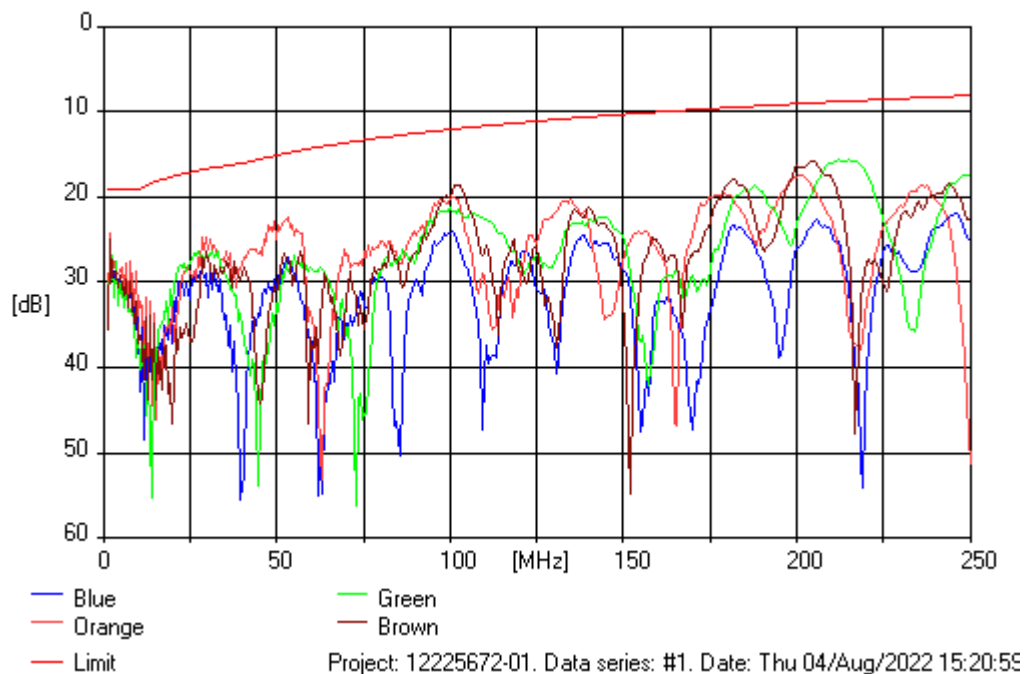

Table 11. Worst case margins at selected nominal frequencies.

Nominal Freq. [MHz]	Meas. Freq. [MHz]	Meas. value [dB]	Limit value [dB]	Calc. margin [dB]
1	1.0	33.3	19.0	14.3
4	4.1	29.0	19.0	10.0
16	15.9	35.7	18.0	17.7
100	100.0	19.9	12.0	7.9
250	250.0	17.5	8.0	9.5

ATTENUATION TO CROSSTALK RATIO, NEAR END (ACR-N). From equipment end
 Channel #1. Worst case margin: 7 dB at 215.1 MHz for Green/Brown-Green pair.

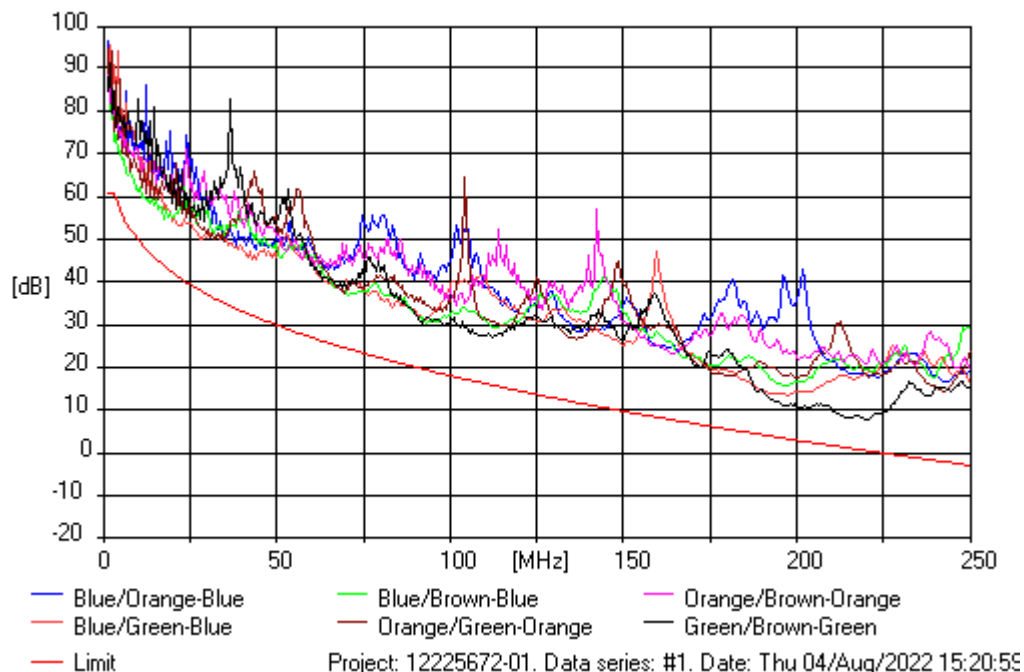

Table 12. Worst case margins at selected nominal frequencies.

Nominal Freq. [MHz]	Meas. Freq. [MHz]	Meas. value [dB]	Limit value [dB]	Calc. margin [dB]
1	1.0	85.2	61.0	24.2
4	4.1	70.9	58.6	12.3
16	15.9	57.1	45.0	12.1
100	100.0	30.8	18.2	12.6
250	250.0	15.4	-2.8	18.2

PS ATT TO CROSSTALK RATIO, NEAR END (PSACR-N). From equipment end
 Channel #1. Worst case margin: 7.9 dB at 196.5 MHz for Green pair.

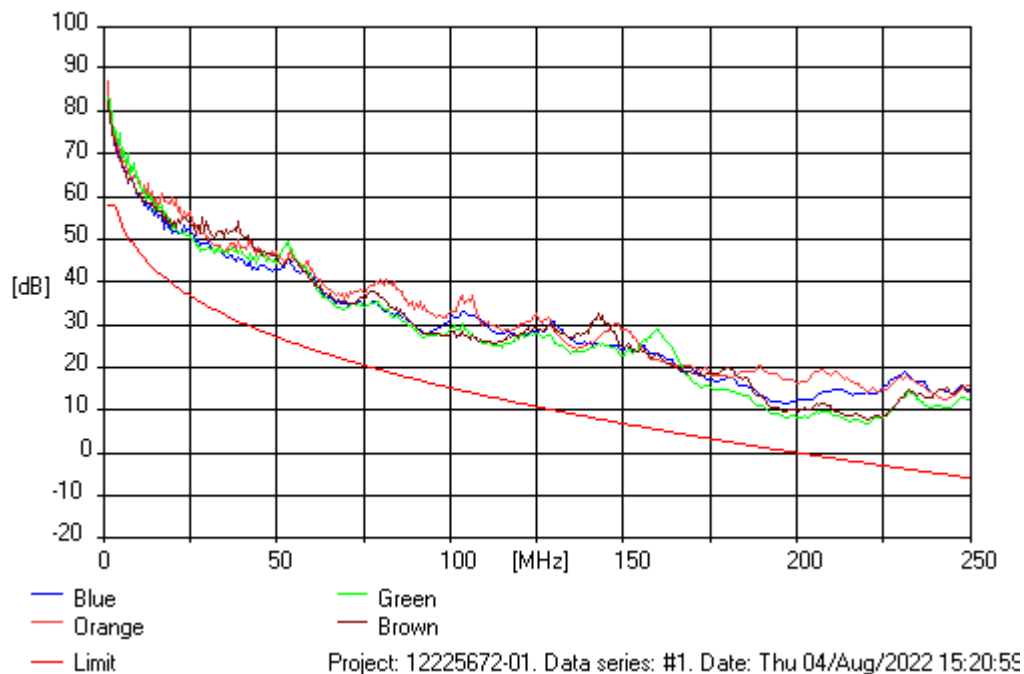

Table 13. Worst case margins at selected nominal frequencies.

Nominal Freq. [MHz]	Meas. Freq. [MHz]	Meas. value [dB]	Limit value [dB]	Calc. margin [dB]
1	1.0	82.4	58.0	24.4
4	4.1	69.7	56.1	13.6
16	15.9	55.3	42.3	13.0
100	100.0	28.3	15.4	12.9
250	250.0	12.5	-5.8	18.3

TRANSVERSE CONVERSION LOSS (TCL). From equipment end
 Channel #1. Worst case margin: 17.3 dB at 208.9 MHz for Orange pair.

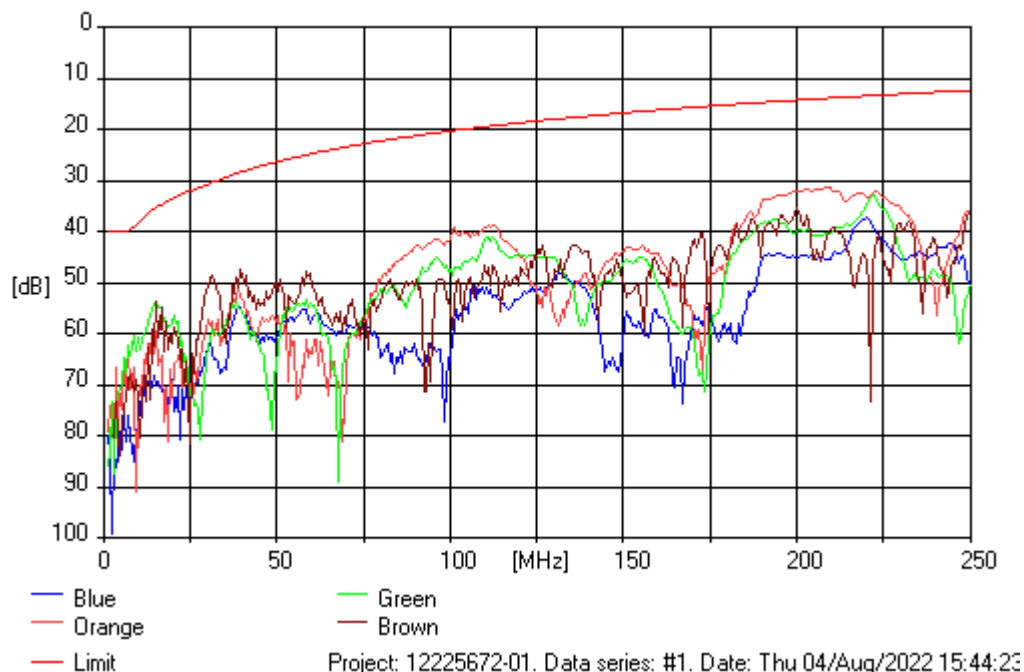

Table 14. Worst case margins at selected nominal frequencies.

Nominal Freq. [MHz]	Meas. Freq. [MHz]	Meas. value [dB]	Limit value [dB]	Calc. margin [dB]
1	1.0	77.6	40.0	37.6
4	4.1	72.1	40.0	32.1
16	15.9	54.6	35.0	19.7
100	100.0	41.3	20.3	21.0
250	250.0	36.3	12.3	24.0

BALANCED MODE ATTENUATION.

Channel #1. Worst case margin: 0.4 dB at 2.9 MHz for Blue pair.

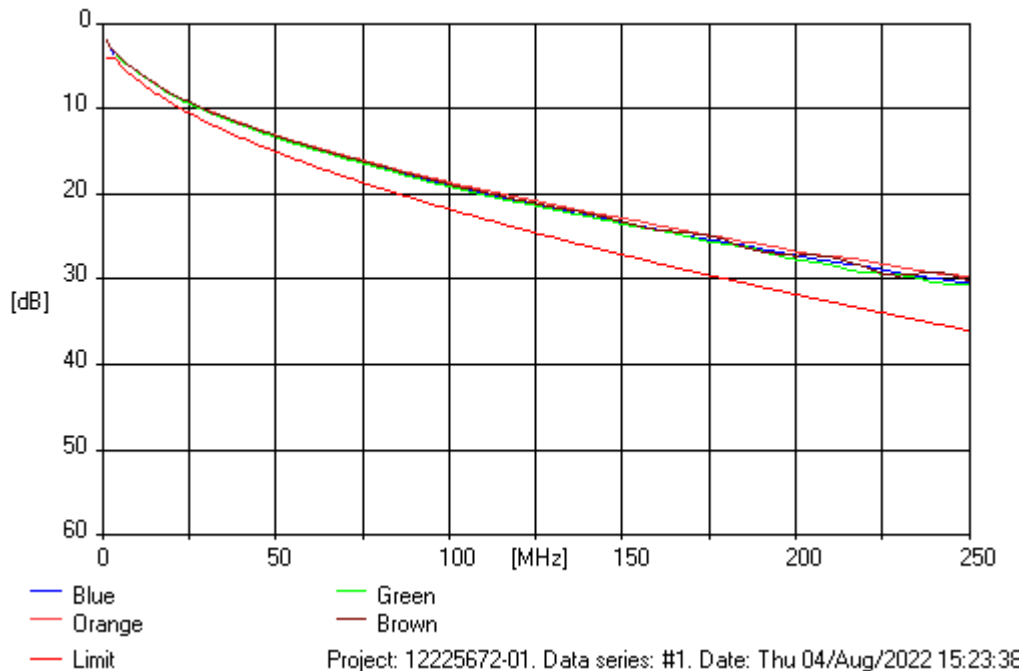
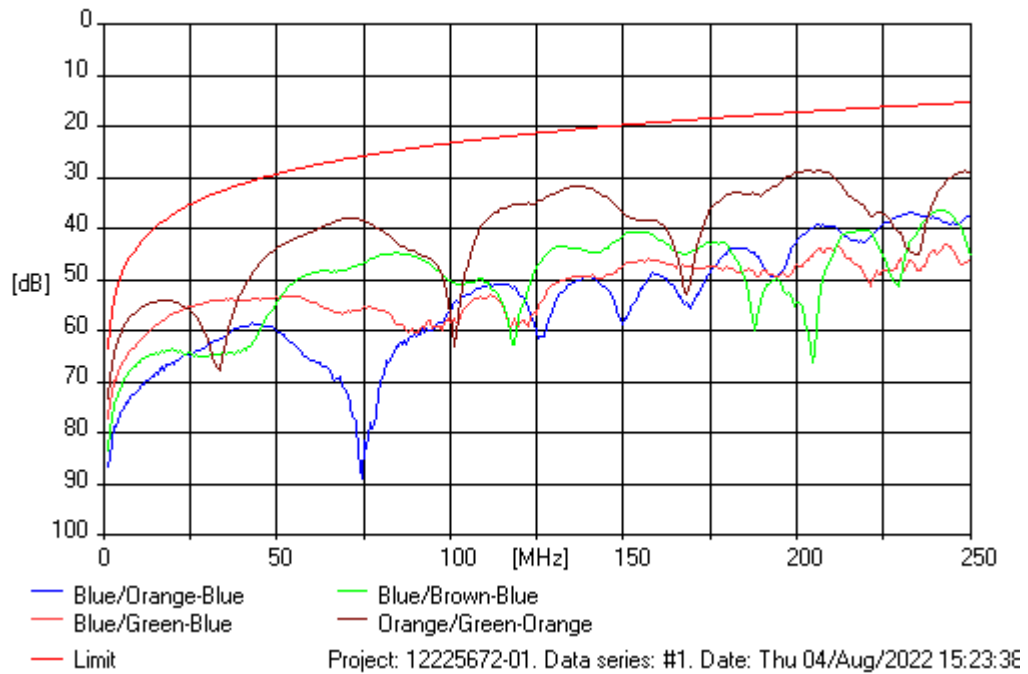

Table 15. Worst case margins at selected nominal frequencies.

Nominal Freq. [MHz]	Meas. Freq. [MHz]	Meas. value [dB]	Limit value [dB]	Calc. margin [dB]
1	1.0	2.0	4.0	2.0
4	4.1	3.6	4.2	0.6
16	15.9	7.2	8.3	1.1
100	100.0	19.0	21.7	2.7
250	250.0	30.6	35.9	5.3

ATTENUATION TO CROSSTALK RATIO - FAR (ACR-F).

Channel #1. Worst case margin: 9.8 dB at 1 MHz for Orange/Green-Orange pair.



ATTENUATION TO CROSSTALK RATIO - FAR (ACR-F).

Channel #1. Worst case margin: 13.2 dB at 242.5 MHz for Green/Brown-Green pair.

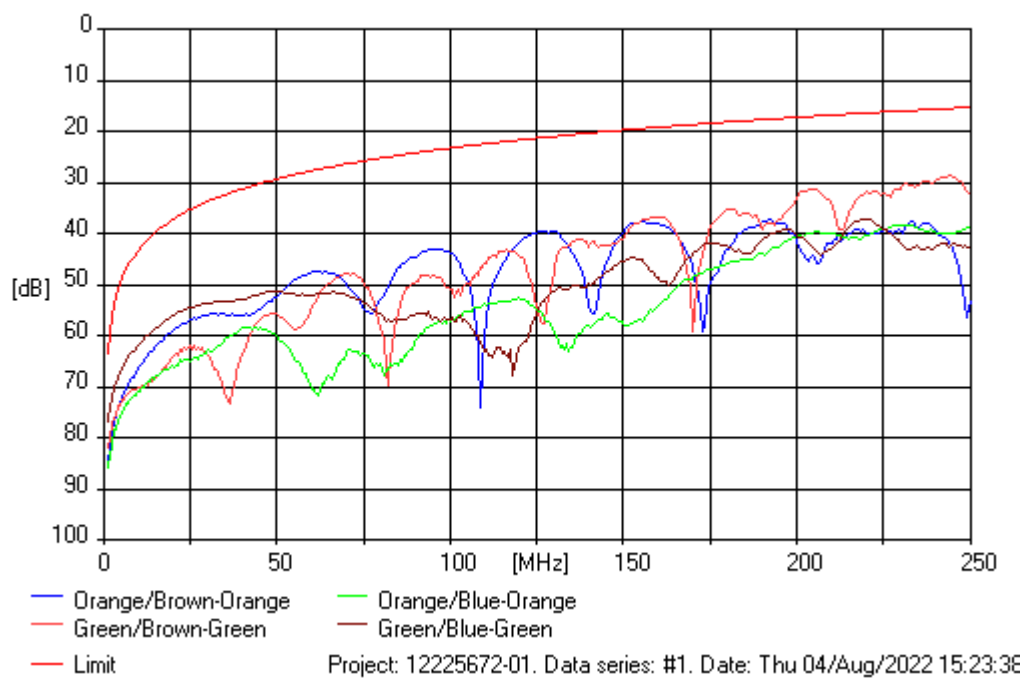

ATTENUATION TO CROSSTALK RATIO - FAR (ACR-F).

Channel #1. Worst case margin: 9.5 dB at 135.5 MHz for Green/Orange-Green pair.

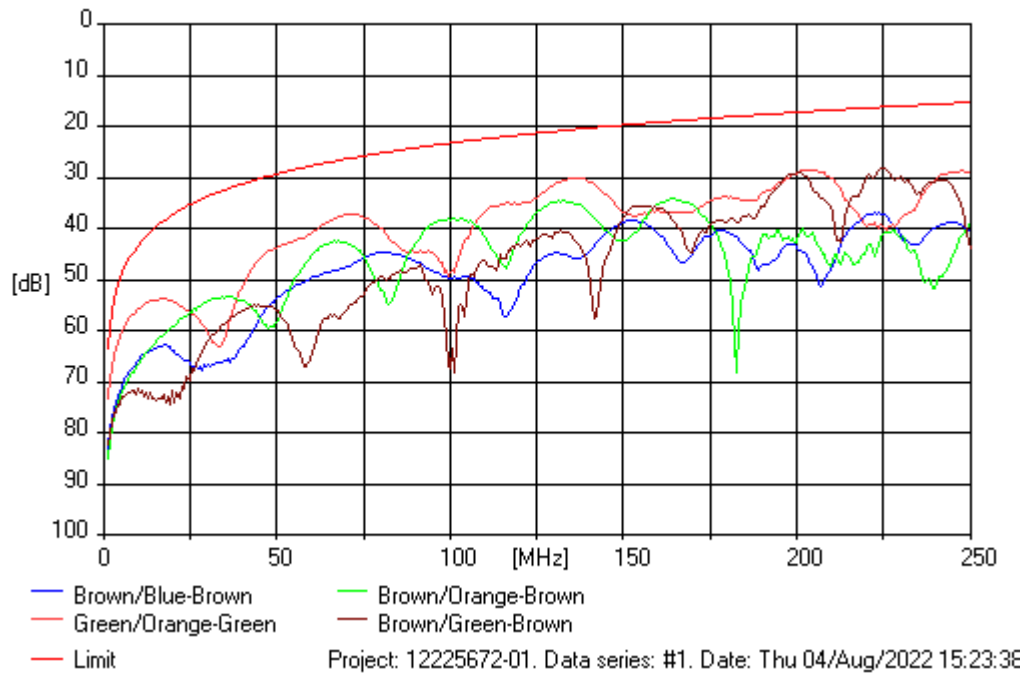

Table 16. Worst case margins at selected nominal frequencies.

Nominal Freq. [MHz]	Meas. Freq. [MHz]	Meas. value [dB]	Limit value [dB]	Calc. margin [dB]
1	1.0	73.0	63.3	9.8
4	4.1	61.9	51.0	10.9
16	15.9	53.9	39.2	14.7
100	100.0	38.2	23.3	14.9
250	250.0	28.9	15.3	13.6

PS SUM ATTENUATION TO CROSSTALK RATIO - FAR (PSACR-F).

Channel #1. Worst case margin: 10.9 dB at 1 MHz for Green pair.

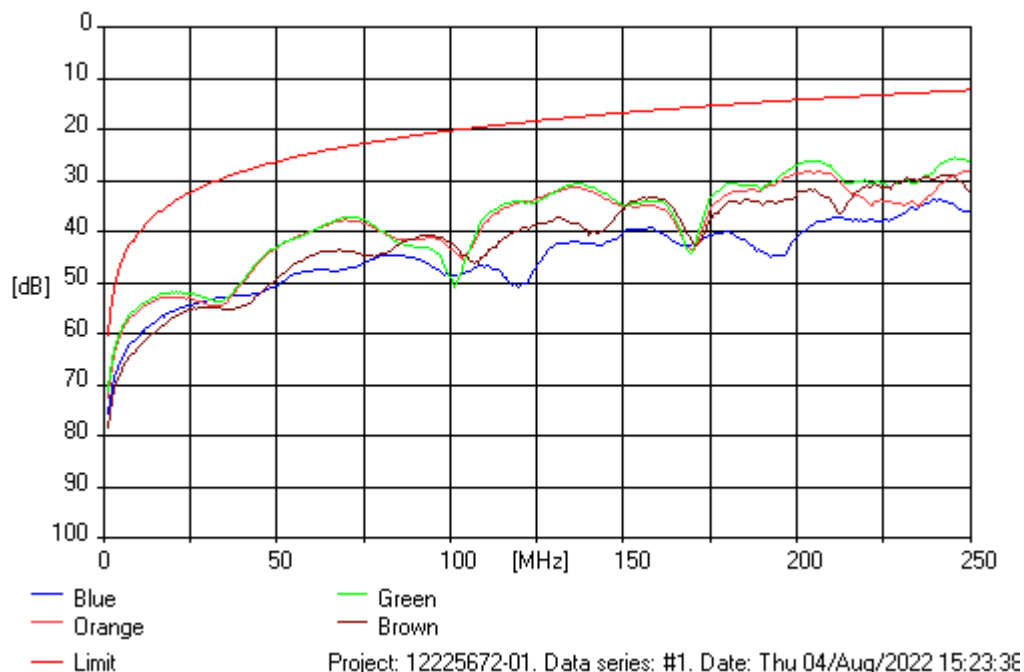

Table 17. Worst case margins at selected nominal frequencies.

Nominal Freq. [MHz]	Meas. Freq. [MHz]	Meas. value [dB]	Limit value [dB]	Calc. margin [dB]
1	1.0	71.2	60.3	10.9
4	4.1	60.7	48.0	12.7
16	15.9	52.6	36.2	16.4
100	100.0	42.2	20.3	22.0
250	250.0	26.5	12.3	14.2

PROPAGATION DELAY.

Channel #1. Worst case margin: 0.07 μ s at 200.2 MHz for Green pair.

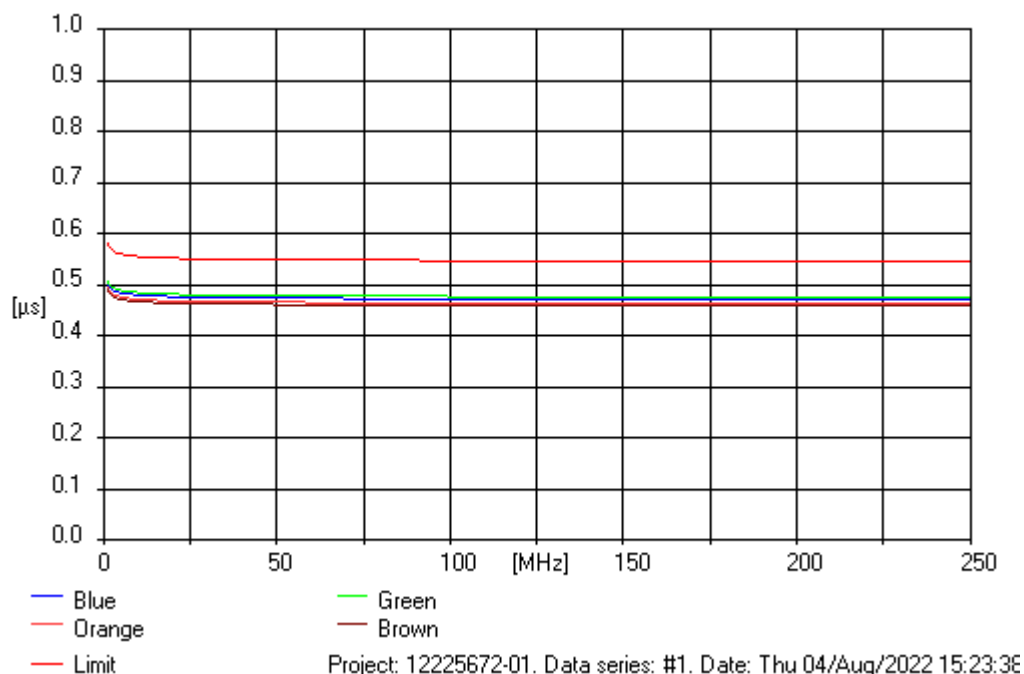

Table 18. Worst case margins at selected nominal frequencies.

Nominal Freq. [MHz]	Meas. Freq. [MHz]	Meas. value [ns]	Limit value [ns]	Calc. margin [ns]
1	1.0	508	580	72
4	4.1	491	562	71
16	15.9	482	553	71
100	100.0	477	548	70
250	250.0	476	546	70

DELAY SKEW.

Channel #1. Worst case margin: 32.5 ns.



Table 19. Worst case margins at selected nominal frequencies.

Nominal Freq. [MHz]	Meas. Freq. [MHz]	Meas. value [ns]	Limit value [ns]	Calc. margin [ns]
1	1.0	17.5	50.0	32.5
4	4.1	17.3	50.0	32.7
16	15.9	17.2	50.0	32.8
100	100.0	17.1	50.0	32.9
250	250.0	17.1	50.0	32.9

4.4 High frequency transmission test results. channel #2 (15 m horizontal cable)

NEAR END CROSSTALK (NEXT). From terminal end

Channel #2. Worst case margin: 3.6 dB at 218.9 MHz for Green /Brown pair.

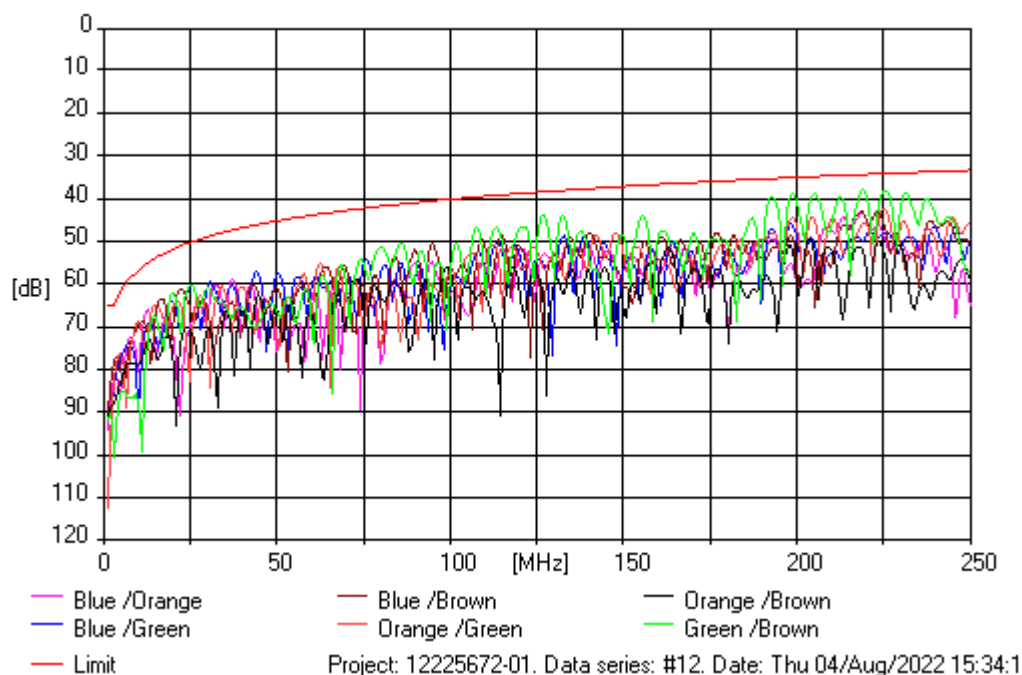

Table 20. Worst case margins at selected nominal frequencies.

Nominal Freq. [MHz]	Meas. Freq. [MHz]	Meas. value [dB]	Limit value [dB]	Calc. margin [dB]
1	1.0	89.0	65.0	24.0
4	4.1	77.0	62.8	14.1
16	15.9	64.1	53.3	10.8
100	100.0	56.1	39.9	16.2
250	250.0	45.7	33.1	12.5

PS NEAR END CROSSTALK(PSNEXT). From terminal end
 Channel #2. Worst case margin: 5.1 dB at 199 MHz for Green pair.

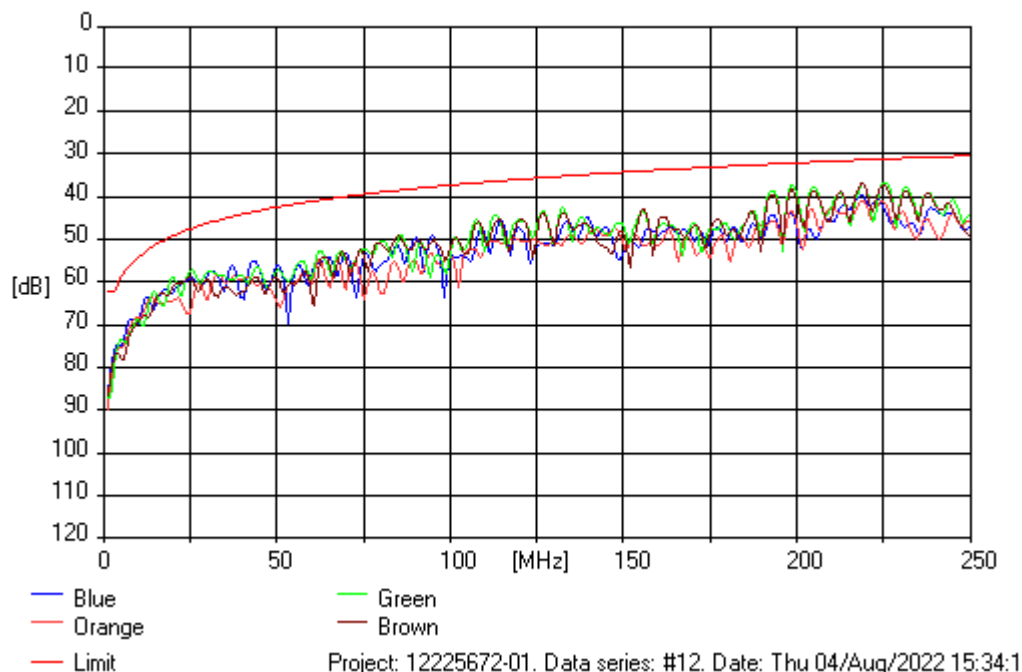

Table 21. Worst case margins at selected nominal frequencies.

Nominal Freq. [MHz]	Meas. Freq. [MHz]	Meas. value [dB]	Limit value [dB]	Calc. margin [dB]
1	1.0	85.8	62.0	23.8
4	4.1	74.3	60.3	14.0
16	15.9	62.8	50.6	12.2
100	100.0	51.8	37.1	14.7
250	250.0	43.8	30.2	13.7

RETURN LOSS. From terminal end

Channel #2. Worst case margin: 4.3 dB at 1.6 MHz for Blue pair.

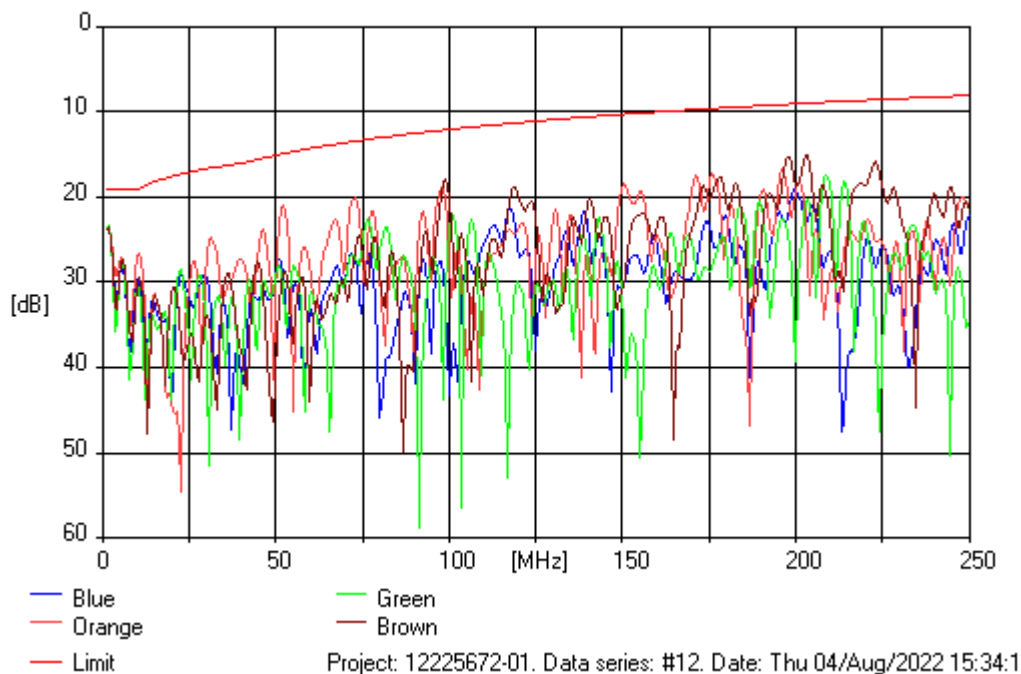

Table 22. Worst case margins at selected nominal frequencies.

Nominal Freq. [MHz]	Meas. Freq. [MHz]	Meas. value [dB]	Limit value [dB]	Calc. margin [dB]
1	1.0	23.4	19.0	4.4
4	4.1	29.2	19.0	10.2
16	15.9	31.9	18.0	13.9
100	100.0	20.1	12.0	8.1
250	250.0	21.1	8.0	13.1

ATTENUATION TO CROSSTALK RATIO, NEAR END (ACR-N). From terminal end
 Channel #2. Worst case margin: 16.2 dB at 3.5 MHz for Blue/Brown-Blue pair.

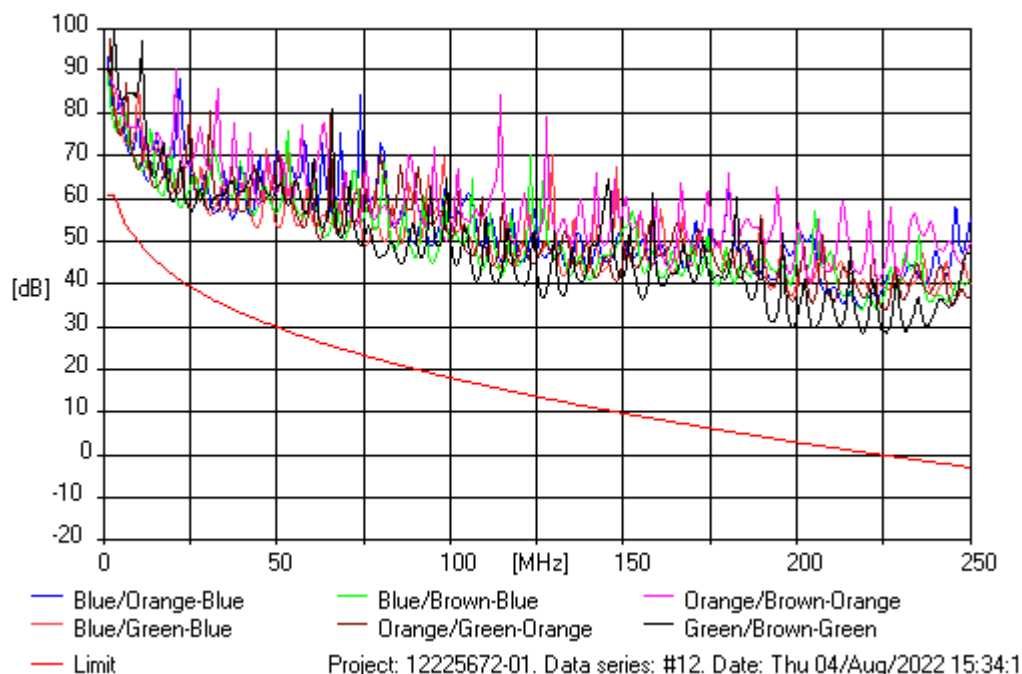

Table 23. Worst case margins at selected nominal frequencies.

Nominal Freq. [MHz]	Meas. Freq. [MHz]	Meas. value [dB]	Limit value [dB]	Calc. margin [dB]
1	1.0	88.5	61.0	27.5
4	4.1	76.0	58.6	17.4
16	15.9	62.0	45.0	17.0
100	100.0	50.5	18.2	32.3
250	250.0	36.7	-2.8	39.5

PS ATT TO CROSSTALK RATIO, NEAR END (PSACR-N). From terminal end
 Channel #2. Worst case margin: 16 dB at 3.5 MHz for Blue pair.

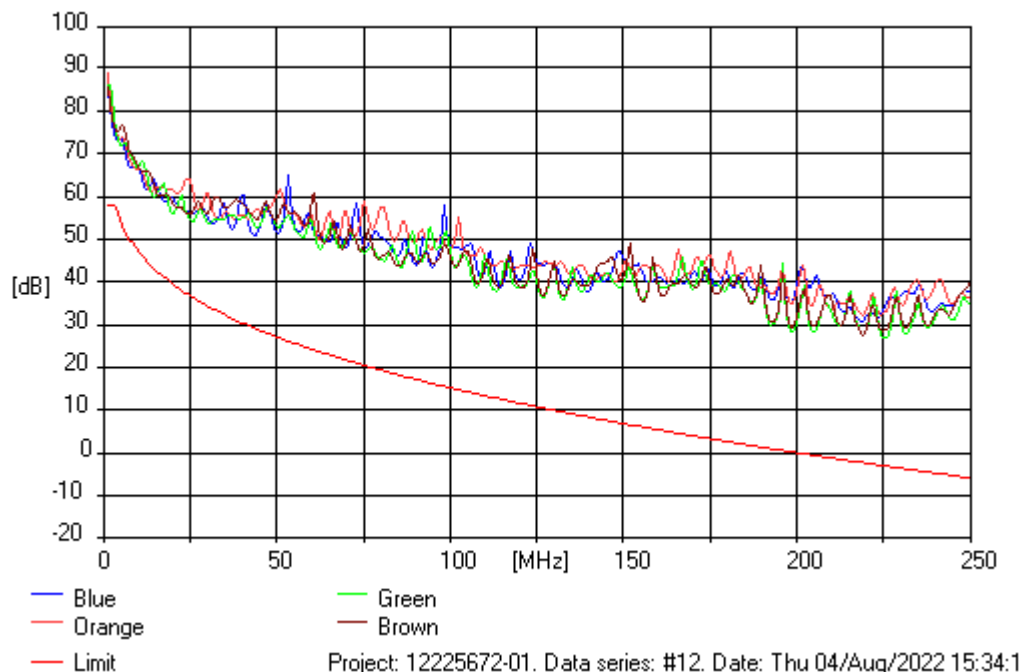

Table 24. Worst case margins at selected nominal frequencies.

Nominal Freq. [MHz]	Meas. Freq. [MHz]	Meas. value [dB]	Limit value [dB]	Calc. margin [dB]
1	1.0	85.3	58.0	27.3
4	4.1	73.3	56.1	17.2
16	15.9	60.8	42.3	18.4
100	100.0	46.1	15.4	30.8
250	250.0	34.5	-5.8	40.3

TRANSVERSE CONVERSION LOSS (TCL). From terminal end

Channel #2. Worst case margin: 13.5 dB at 203.3 MHz for Orange pair.

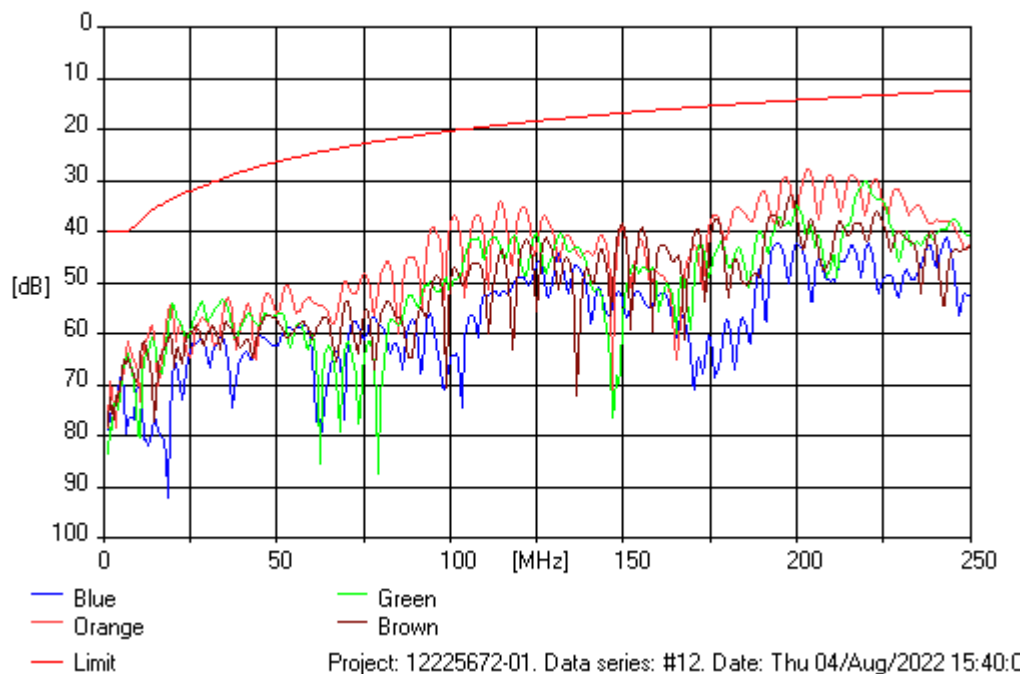

Table 25. Worst case margins at selected nominal frequencies.

Nominal Freq. [MHz]	Meas. Freq. [MHz]	Meas. value [dB]	Limit value [dB]	Calc. margin [dB]
1	1.0	77.8	40.0	37.8
4	4.1	71.4	40.0	31.4
16	15.9	65.8	35.0	30.8
100	100.0	38.2	20.3	17.9
250	250.0	41.0	12.3	28.7

NEAR END CROSSTALK (NEXT). From equipment end

Channel #2. Worst case margin: 0.5 dB at 205.2 MHz for Green /Brown pair.

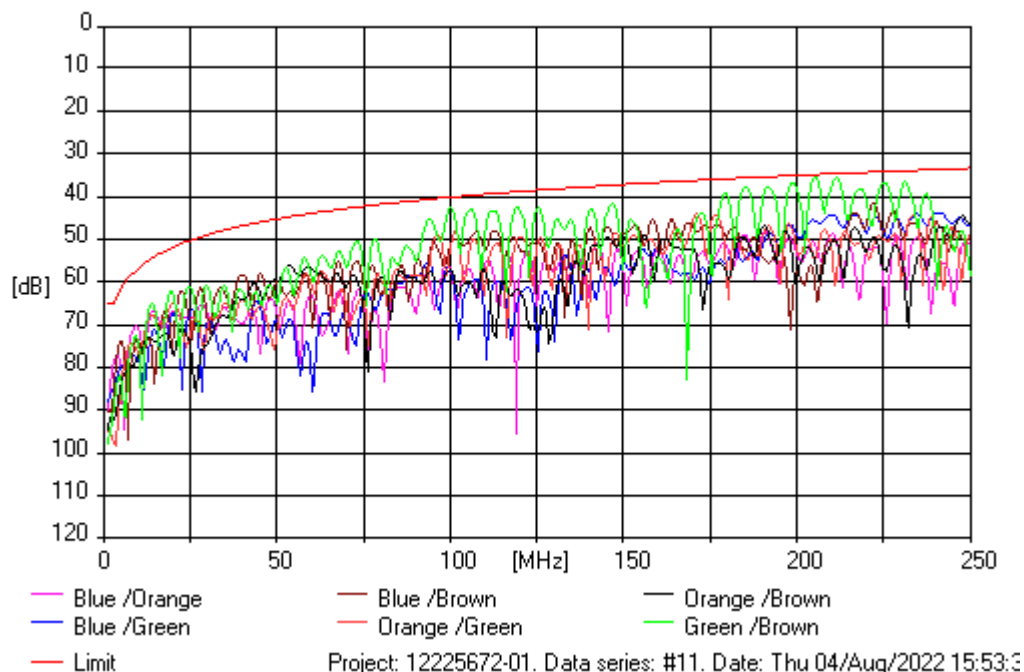

Table 26. Worst case margins at selected nominal frequencies.

Nominal Freq. [MHz]	Meas. Freq. [MHz]	Meas. value [dB]	Limit value [dB]	Calc. margin [dB]
1	1.0	88.1	65.0	23.1
4	4.1	75.1	62.8	12.2
16	15.9	68.4	53.3	15.1
100	100.0	42.4	39.9	2.4
250	250.0	46.4	33.1	13.3

PS NEAR END CROSSTALK(PSNEXT). From equipment end
 Channel #2. Worst case margin: 3 dB at 205.2 MHz for Green pair.

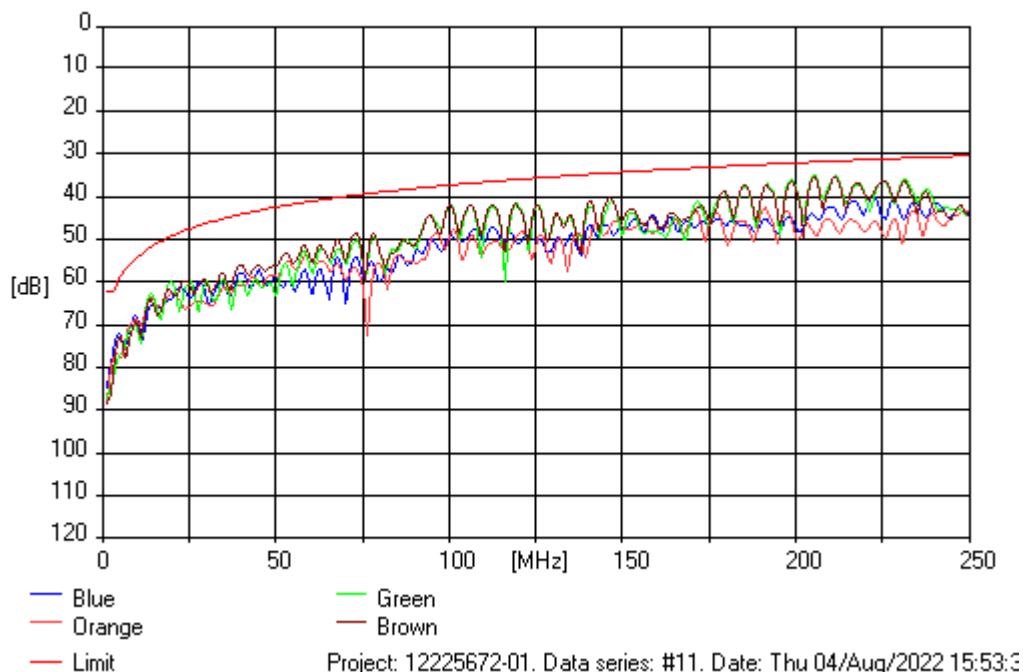

Table 27. Worst case margins at selected nominal frequencies.

Nominal Freq. [MHz]	Meas. Freq. [MHz]	Meas. value [dB]	Limit value [dB]	Calc. margin [dB]
1	1.0	84.6	62.0	22.6
4	4.1	72.4	60.3	12.0
16	15.9	65.1	50.6	14.5
100	100.0	41.7	37.1	4.6
250	250.0	43.5	30.2	13.3

RETURN LOSS. From equipment end

Channel #2. Worst case margin: 4.2 dB at 1.6 MHz for Blue pair.

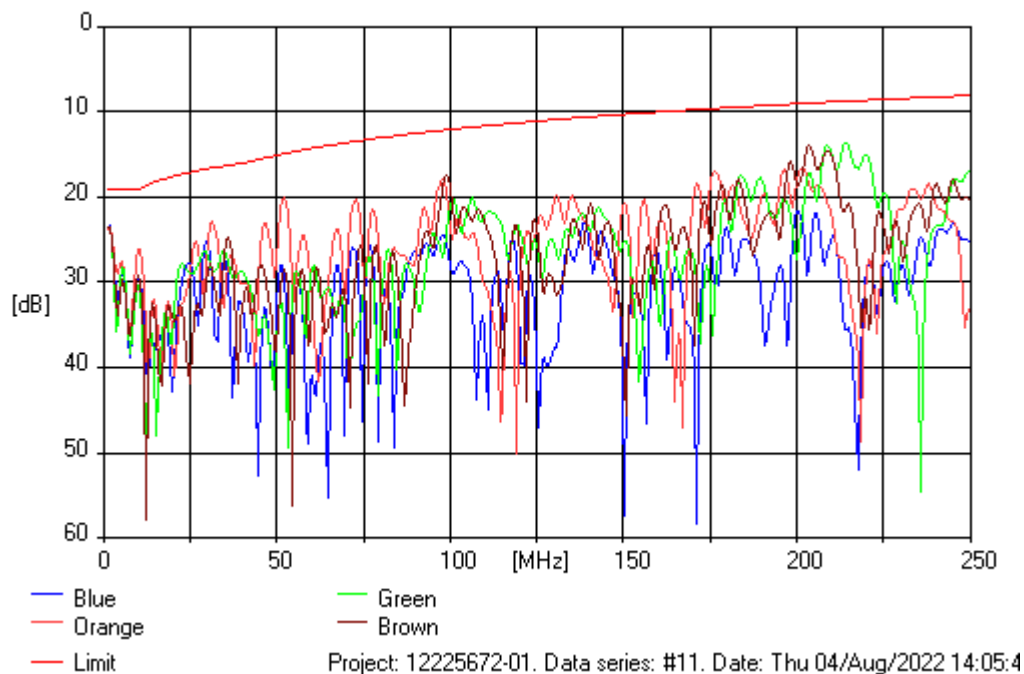

Table 28. Worst case margins at selected nominal frequencies.

Nominal Freq. [MHz]	Meas. Freq. [MHz]	Meas. value [dB]	Limit value [dB]	Calc. margin [dB]
1	1.0	23.4	19.0	4.4
4	4.1	28.9	19.0	9.9
16	15.9	36.6	18.0	18.6
100	100.0	18.9	12.0	6.9
250	250.0	16.8	8.0	8.8

ATTENUATION TO CROSSTALK RATIO, NEAR END (ACR-N). From equipment end
 Channel #2. Worst case margin: 15.4 dB at 4.7 MHz for Blue/Brown-Blue pair.

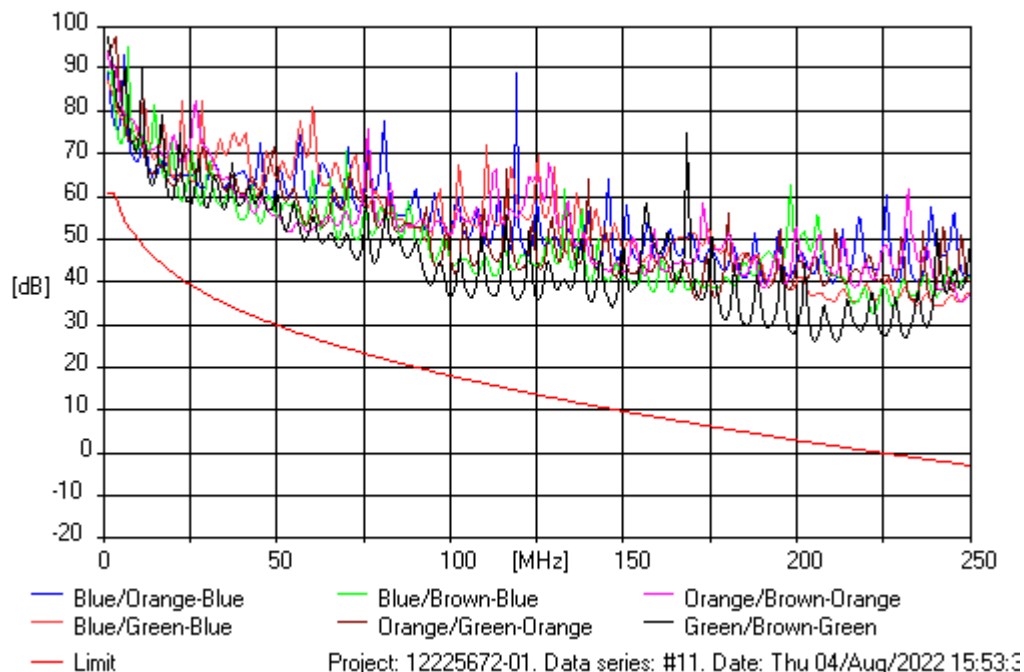

Table 29. Worst case margins at selected nominal frequencies.

Nominal Freq. [MHz]	Meas. Freq. [MHz]	Meas. value [dB]	Limit value [dB]	Calc. margin [dB]
1	1.0	87.6	61.0	26.6
4	4.1	74.0	58.6	15.4
16	15.9	66.3	45.0	21.3
100	100.0	36.6	18.2	18.4
250	250.0	37.5	-2.8	40.4

PS ATT TO CROSSTALK RATIO, NEAR END (PSACR-N). From equipment end
 Channel #2. Worst case margin: 15.2 dB at 4.1 MHz for Blue pair.

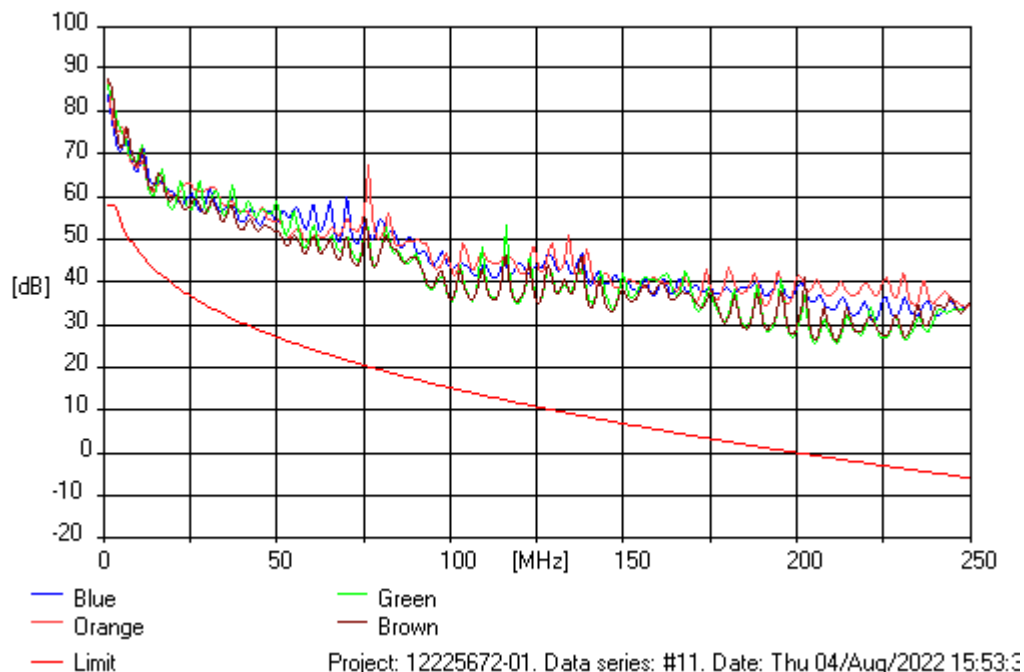

Table 30. Worst case margins at selected nominal frequencies.

Nominal Freq. [MHz]	Meas. Freq. [MHz]	Meas. value [dB]	Limit value [dB]	Calc. margin [dB]
1	1.0	84.1	58.0	26.1
4	4.1	71.4	56.1	15.2
16	15.9	63.1	42.3	20.8
100	100.0	35.9	15.4	20.6
250	250.0	34.7	-5.8	40.5

TRANSVERSE CONVERSION LOSS (TCL). From equipment end
 Channel #2. Worst case margin: 15.1 dB at 114.3 MHz for Orange pair.

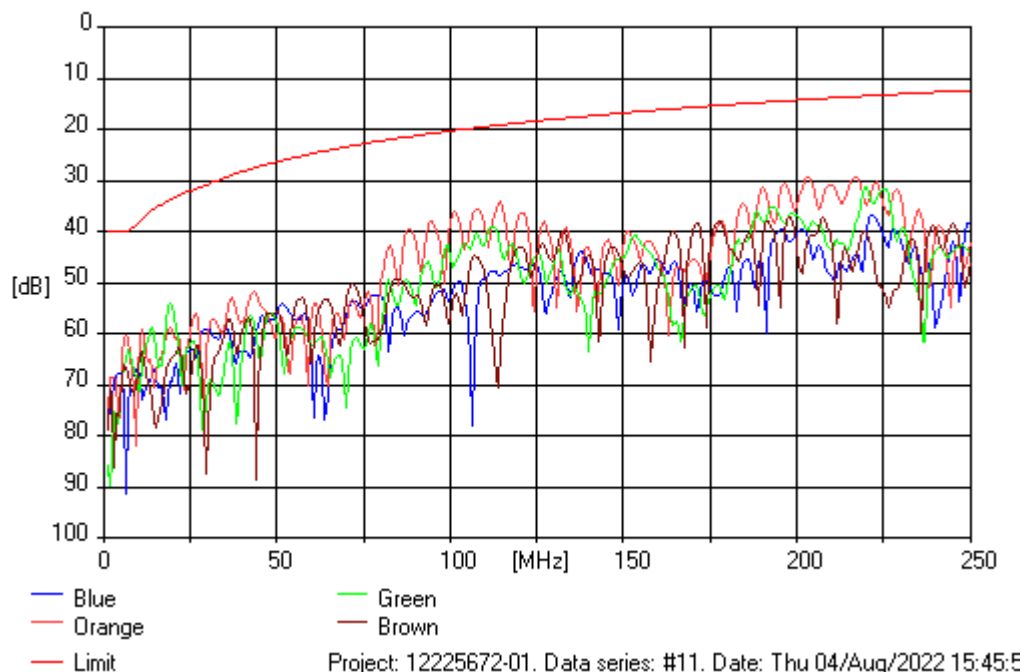

Table 31. Worst case margins at selected nominal frequencies.

Nominal Freq. [MHz]	Meas. Freq. [MHz]	Meas. value [dB]	Limit value [dB]	Calc. margin [dB]
1	1.0	75.9	40.0	35.9
4	4.1	67.9	40.0	27.9
16	15.9	65.6	35.0	30.6
100	100.0	38.1	20.3	17.8
250	250.0	38.4	12.3	26.1

BALANCED MODE ATTENUATION.

Channel #2. Worst case margin: 3.1 dB at 3.5 MHz for Orange pair.

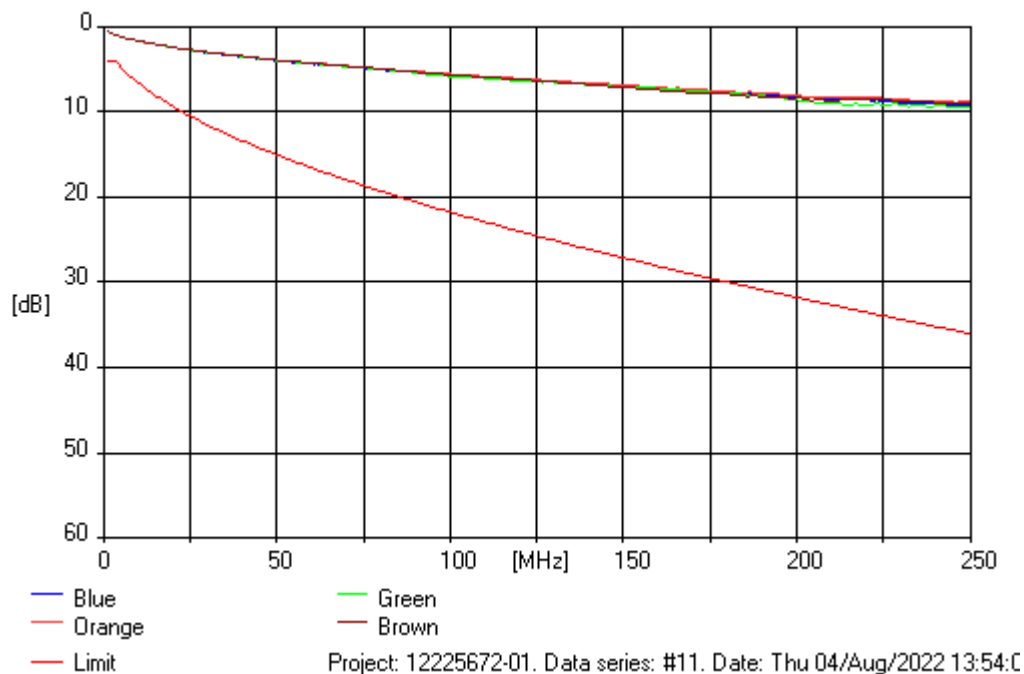
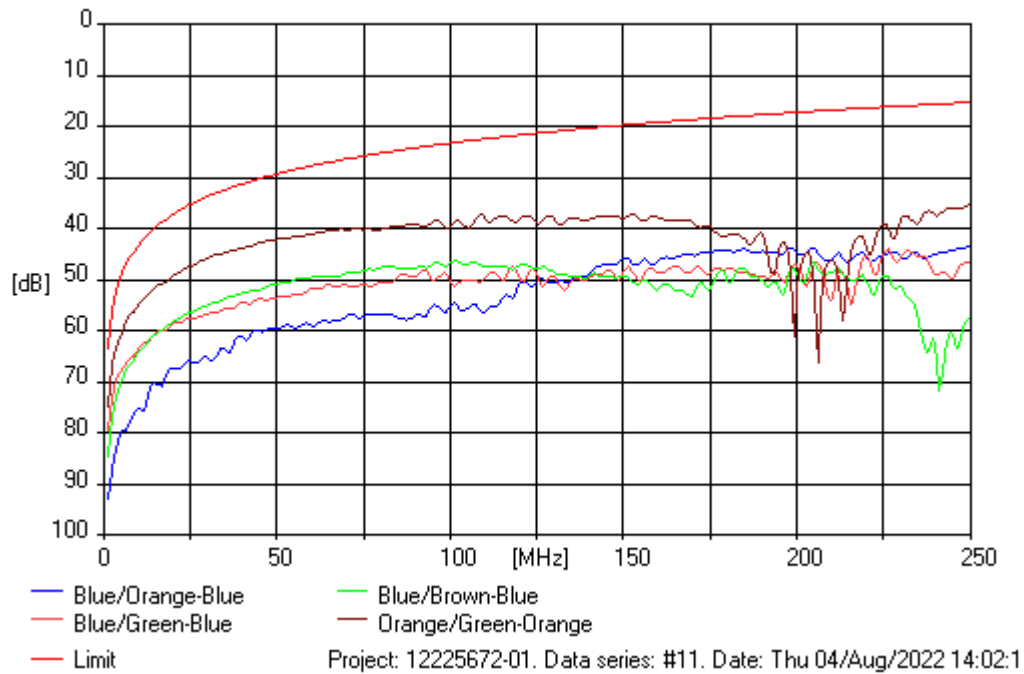

Table 32. Worst case margins at selected nominal frequencies.

Nominal Freq. [MHz]	Meas. Freq. [MHz]	Meas. value [dB]	Limit value [dB]	Calc. margin [dB]
1	1.0	0.5	4.0	3.5
4	4.1	1.0	4.2	3.2
16	15.9	2.1	8.3	6.2
100	100.0	5.8	21.7	15.9
250	250.0	9.3	35.9	26.6

ATTENUATION TO CROSSTALK RATIO - FAR (ACR-F).

Channel #2. Worst case margin: 10.7 dB at 2.9 MHz for Orange/Green-Orange pair.



ATTENUATION TO CROSSTALK RATIO - FAR (ACR-F).

Channel #2. Worst case margin: 15.9 dB at 1 MHz for Green/Blue-Green pair.

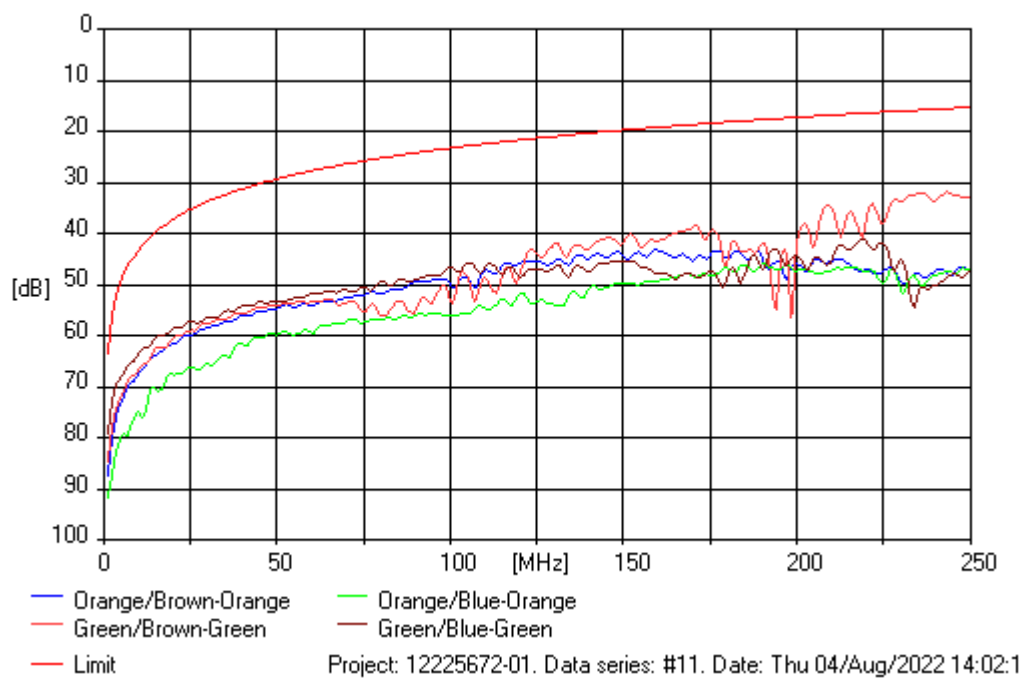

ATTENUATION TO CROSSTALK RATIO - FAR (ACR-F).

Channel #2. Worst case margin: 10.8 dB at 2.2 MHz for Green/Orange-Green pair.

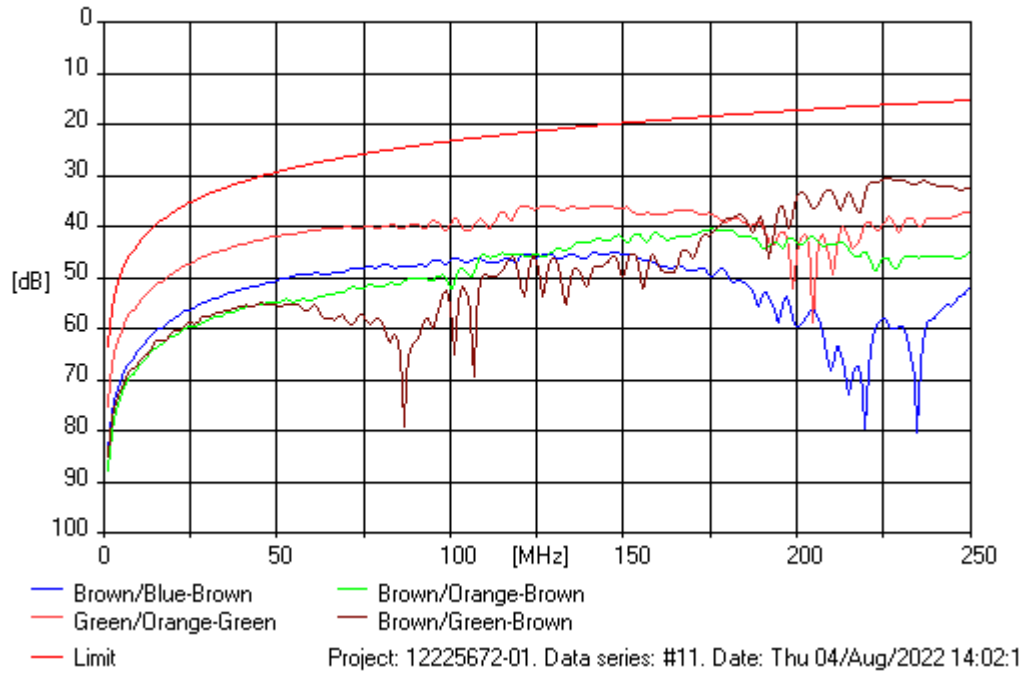

Table 33. Worst case margins at selected nominal frequencies.

Nominal Freq. [MHz]	Meas. Freq. [MHz]	Meas. value [dB]	Limit value [dB]	Calc. margin [dB]
1	1.0	74.9	63.3	11.6
4	4.1	62.2	51.0	11.3
16	15.9	51.0	39.2	11.8
100	100.0	39.5	23.3	16.3
250	250.0	32.5	15.3	17.2

PS SUM ATTENUATION TO CROSSTALK RATIO - FAR (PSACR-F).

Channel #2. Worst case margin: 12.5 dB at 2.9 MHz for Green pair.

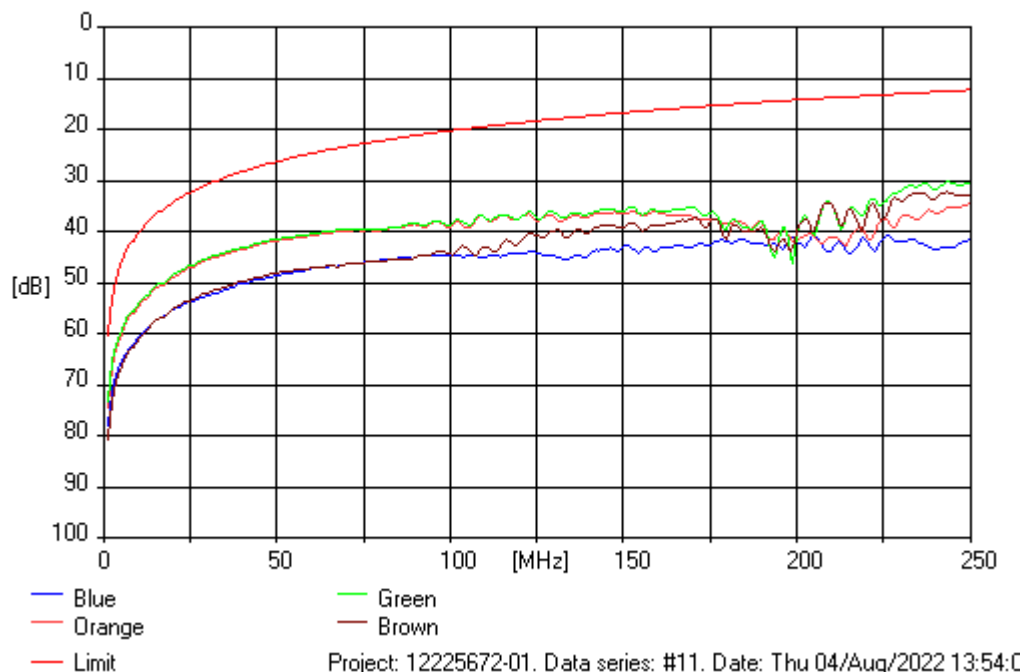

Table 34. Worst case margins at selected nominal frequencies.

Nominal Freq. [MHz]	Meas. Freq. [MHz]	Meas. value [dB]	Limit value [dB]	Calc. margin [dB]
1	1.0	73.2	60.3	13.0
4	4.1	61.1	48.0	13.2
16	15.9	50.2	36.2	14.0
100	100.0	38.7	20.3	18.5
250	250.0	30.7	12.3	18.4

PROPAGATION DELAY.

Channel #2. Worst case margin: 0.425 μ s at 250 MHz for Orange pair.

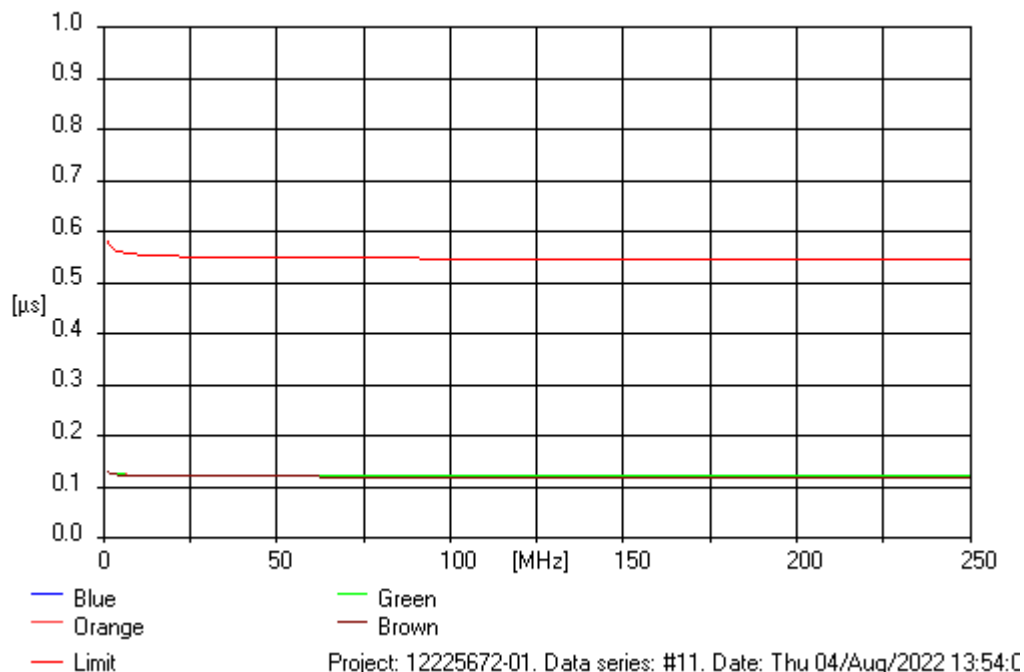

Table 35. Worst case margins at selected nominal frequencies.

Nominal Freq. [MHz]	Meas. Freq. [MHz]	Meas. value [ns]	Limit value [ns]	Calc. margin [ns]
1	1.0	131	580	449
4	4.1	126	562	436
16	15.9	123	553	430
100	100.0	122	548	426
250	250.0	122	546	425

DELAY SKEW.

Channel #2.' Worst case margin: 48.6 ns.

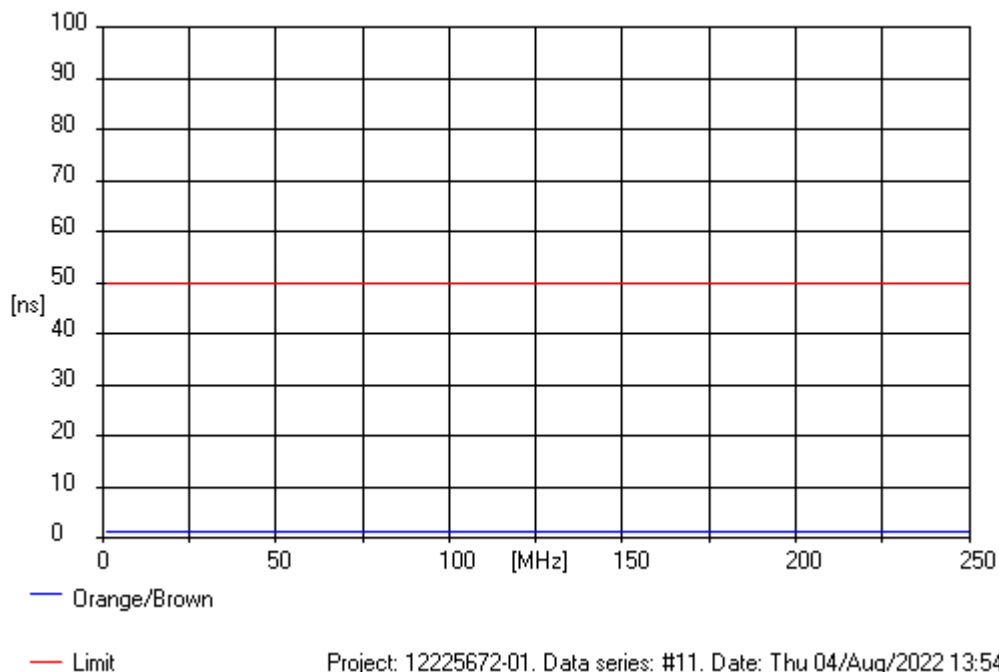

Table 36. Worst case margins at selected nominal frequencies.

Nominal Freq. [MHz]	Meas. Freq. [MHz]	Meas. value [ns]	Limit value [ns]	Calc. margin [ns]
1	1.0	1.3	50.0	48.7
4	4.1	1.4	50.0	48.6
16	15.9	1.4	50.0	48.6
100	100.0	1.3	50.0	48.7
250	250.0	1.3	50.0	48.7

Equipment:

Network Analyser, Hewlett Packard, type 8753E
 Switch, Agilent, type 87050A
 Balun, BH, type 040-0192
 Balun, BH, type 040-0192
 Balun, BH, type 040-0192

Instrument no.: 31109
 Instrument no.: 31173
 Instrument no.: 31175 to 31178
 Instrument no.: 31179 to 31182
 Instrument no.: 31184

4.5 Resistance properties

Table 37. DC loop resistance, channel #1

Pair	Resistance [Ohm]	Requirement	Compliance
1	15.1	< 25	YES
2	15.2		YES
3	15.3		YES
4	15.0		YES

Table 38. DC resistance unbalance, channel #1

Pair	R unbalance [%]	Requirement	Compliance
1	0.1	< 3 %	YES
2	0.5		YES
3	0.6		YES
4	0.7		YES

Equipment:

Multimeter, Keithley, type 2000

Instrument no.: 31092

5 Reference to applicable standards and documents

Test of the cabling product is performed with reference to the following standards:

5.1 Generic cabling standards

ISO/IEC 11801-1:2017 (Ed. 1.0)

Information technology - Generic cabling for customer premises -
Part 1: General requirements

ISO/IEC 11801-2:2017 (Ed. 1.0)

Information technology - Generic cabling for customer premises -
Part 2: Office premises

CENELEC EN 50173-1:2018

Information Technology - Generic cabling systems - Part 1: General requirements

CENELEC EN 50173-2:2018

Information technology - Generic cabling systems - Part 2: Office spaces

TIA-568.2-D:2018

Balanced Twisted-Pair Telecommunications Cabling and Components Standard

5.2 Special requirements for EC VERIFIED

DQP231006 (version 29, May 2018)

Terms and conditions for the EC VERIFIED programme for Generic and Coaxial cabling

6 Test procedures

The tests carried out on the communication cabling under test are performed according to the standard: IEC 61935-1 Specification for the testing of balanced and coaxial information technology cabling - Part 1: Installed balanced cabling as specified in ISO/IEC 11801 and related standards.

The test methods are detailed in test procedures worked out by FORCE and approved by DANAK. In this section the procedures are described briefly.

6.1 Electrical test

The electrical tests on the communication channel under test are performed according to the procedures described in this section. The performed tests are shown in the following table. The floor cable is stretched on a non-conductive surface.

Table 39. Performed tests

	Measured from	
	Equipment end (patch panel)	Terminal end (wall outlet)
Attenuation	x	
Near end crosstalk (NEXT)	x	x
Attenuation to crosstalk, far (ACR-F)	x	
Return loss	x	x
Propagation delay	x	
Delay skew	x	
TCL	x	x
Resistance properties	x	

6.1.1 Attenuation (Att)

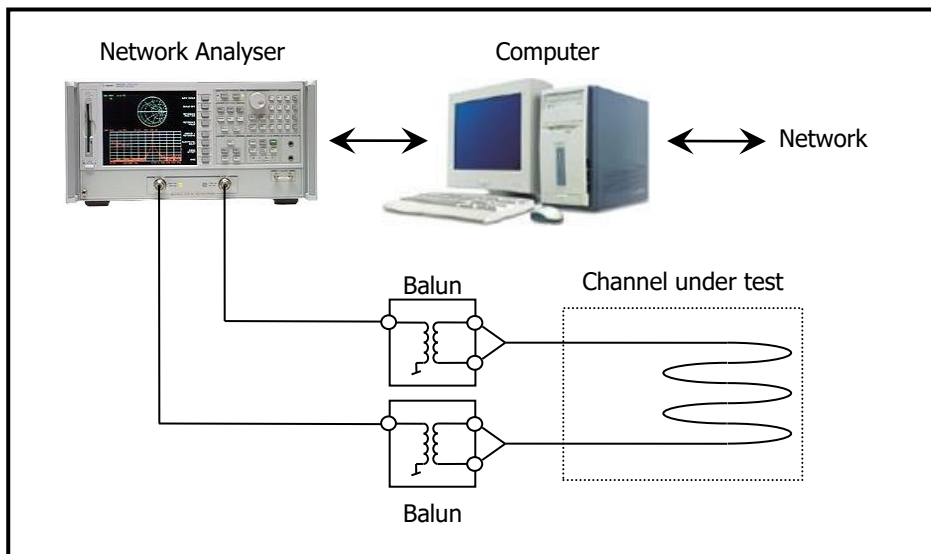

Figure 3. Test set-up for attenuation measurements.

Terminal end and equipment end are connected to one balun each.

The measurement uncertainty for Attenuation is dependent of the level of measured Attenuation. The uncertainty is shown in the table below:

Measured attenuation	Uncertainty
1 dB	± 0.1 dB
10 dB	± 0.3 dB
60 dB	± 0.5 dB
80 dB	± 2 dB

6.1.2 Return loss (RL)

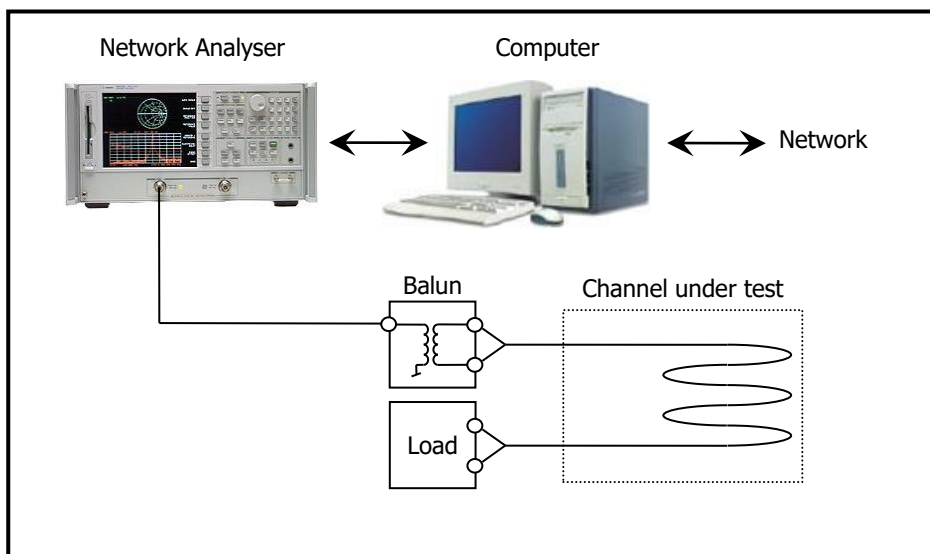

Figure 4. Test set-up for return loss measurements.

The return loss of the channel under test is measured with the far end terminated with a resistance of the specified characteristic impedance of the channel under test.

The measurement uncertainty for impedance is $\pm 1.7\%$ at 100 MHz.

The measurement uncertainty for return loss is dependent of the measured return loss value. The error band is specified in the table below:

Measured return loss	Error band
5 dB	± 0.2 dB
10 dB	± 0.3 dB
15 dB	± 0.5 dB
20 dB	± 1 dB
25 dB	± 2 dB
30 dB	± 3 dB

At frequencies above 500 MHz add ± 1 dB to the uncertainty.

6.1.3 Near end crosstalk (NEXT)

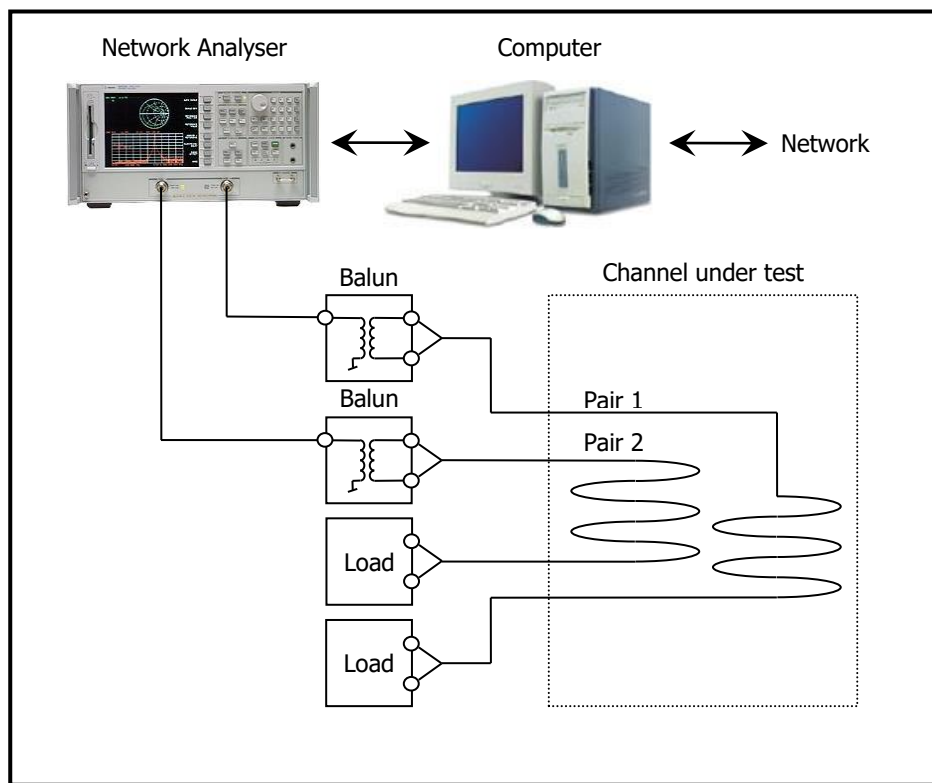

Figure 5. Test set-up for near end crosstalk measurements.

Near end crosstalk, NEXT, is measured as the attenuation from one pair to the others and these measurements are repeated for all pair combinations.

In the far end all pairs are terminated with a resistor with a value of the nominal characteristic impedance of the component under test.

The measurement uncertainty for NEXT is dependent of the level of measured NEXT.

The uncertainty is shown in the table below:

Measured NEXT	Uncertainty
40 dB	±0.5 dB
60 dB	±0.6 dB
70 dB	±0.8 dB
80 dB	±1.7 dB

6.1.4 Powersum near end crosstalk (PSNEXT)

PSNEXT is calculated for each pair according to the formula:

$$PSNEXT = -10 \log(10^{-x1/10} + 10^{-x2/10} + 10^{-x3/10})$$

where x1, x2, x3 are the pair-to-pair crosstalk measurements in dB between the selected pair and the other three pairs.

The measurement uncertainty is the same as for NEXT measurements.

6.1.5 Attenuation to crosstalk loss ratio (ACR-N)

Attenuation to crosstalk ratio loss near end, ACR-N is calculated for each pair as the difference between the near end crosstalk loss and the attenuation.

The measurement uncertainty is the same as for NEXT measurements.

6.1.6 Power sum ACR (PSACR-N)

PSACR-N is calculated according to the formula:

$$PSACR - N = -10 \log (10^{-x1/10} + 10^{-x2/10} + 10^{-x3/10})$$

where x1, x2 and x3 are the ACR-N values in dB between the selected pair and the other three pairs.

The measurement uncertainty is the same as for NEXT measurements.

6.1.7 Attenuation to crosstalk ratio-far end (ACR-F)

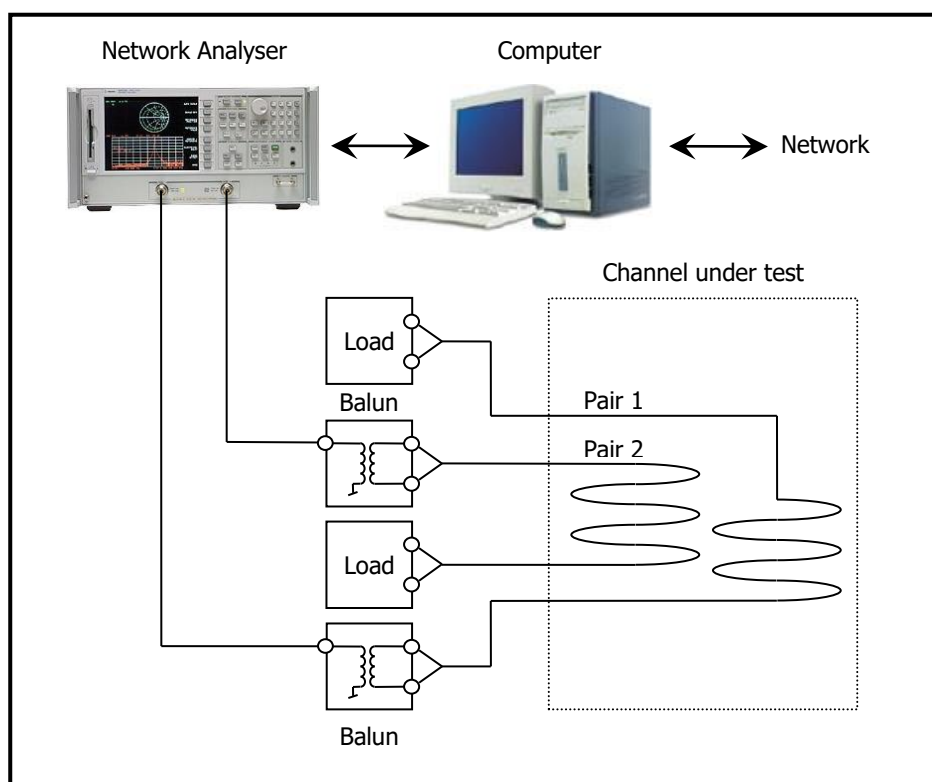

Figure 6. Test set-up for far end crosstalk measurements.

ACR-F is calculated from the measured values of far end cross talk, FEXT and attenuation, ATT.

$$ACR-F = FEXT - ATT$$

The measurement uncertainty for ACR-F is the sum of uncertainties for NEXT and ATT.

6.1.8 Power sum attenuation to crosstalk ratio far end (PSACR-F)

PSACR-F is calculated for each pair according to the equation:

$$PSACR - F = PSFEXT - ATTENUATION$$

$$PSFEXT = -10 \log (10^{-x1/10} + 10^{-x2/10} + 10^{-x3/10})$$

Where x1, x2, x3 are the pair-to-pair crosstalk measurements in dB between the selected pair and the other three pairs.

6.1.9 Unbalance attenuation, near end (Transverse conversion loss, TCL)

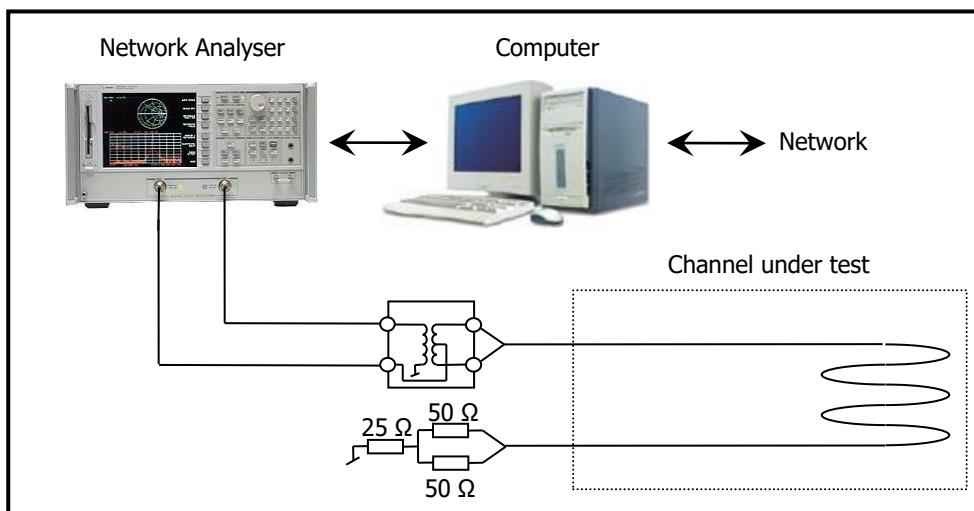

Figure 7. Test set-up for balance characteristics measurements.

Balance characteristics, transverse conversion loss, is measured as the signal attenuation between the common mode and the differential mode port of the test balun.

The test set-up is calibrated by imposing a known unbalance, consisting of a 50 Ohm resistor from one of the balance output terminals to ground. The instrument is adjusted for a reading of 16 dB for this unbalance. All pairs are terminated for differential and common mode signals during the test.

The measurement uncertainty for balance measurements is dependent of the level of balance. The uncertainty is shown in the table below:

Measured TCL	Uncertainty
20 dB	± 0.3 dB
30 dB	± 1 dB
40 dB	± 3 dB

6.1.10 DC loop resistance

DC loop resistance is measured for each conductor in a pair. The loop resistance is calculated by adding the resistance of each conductor. The measured value is corrected for the temperature of the test object in order to obtain the resistance at 20 °C.

The measurement uncertainty for DC resistance is ± 1.4 %.

6.1.11 Propagation delay

Propagation delay is measured by determining the phase delay of a signal transmitted through the cable.

$$\delta = \frac{\varphi}{2\pi \times f}$$

where φ is the phase delay, f is the frequency in Hertz.

The measurement uncertainty for delay is ± 1 %.

6.1.12 Delay skew

Delay skew is calculated as the difference between the maximum and minimum propagation delay over the four pairs at each frequency.

The measurement uncertainty for skew is ± 10 %.



APPENDIX

Appendix 1 Test software

Test software according to information in the table below is used for the conducted tests.

Software name	Function	File name	Version	Date
Cablingtotal	Electrical cable HF tests	Cabltot	4.14	19.03.2021
ECCalculate	Calculated parameters	ECCalculate	12.00	15.11.2019
ECReport	Makes graphs	Xreport.exe	43.00	01.08.2014
Report 2002	Automatic report processing	Rapport.exe	2.4	25.11.2020
Report 2002 Database	Data and documents	Cable report	5.80	15.06.2021
Journal	Keeps journal data	Journal*.xlsm	5.00	01.06.2021
Worksheets	Keeps data	Work*.xlsm	7.0	17.12.2021